



World Robot Olympiad 2020

Advanced Robotics Category

Game Description, Rules and Scoring

SMART Greenhouse

Version: January 15th
(changes compared to 2019 in red)



WRO International Premium Partners

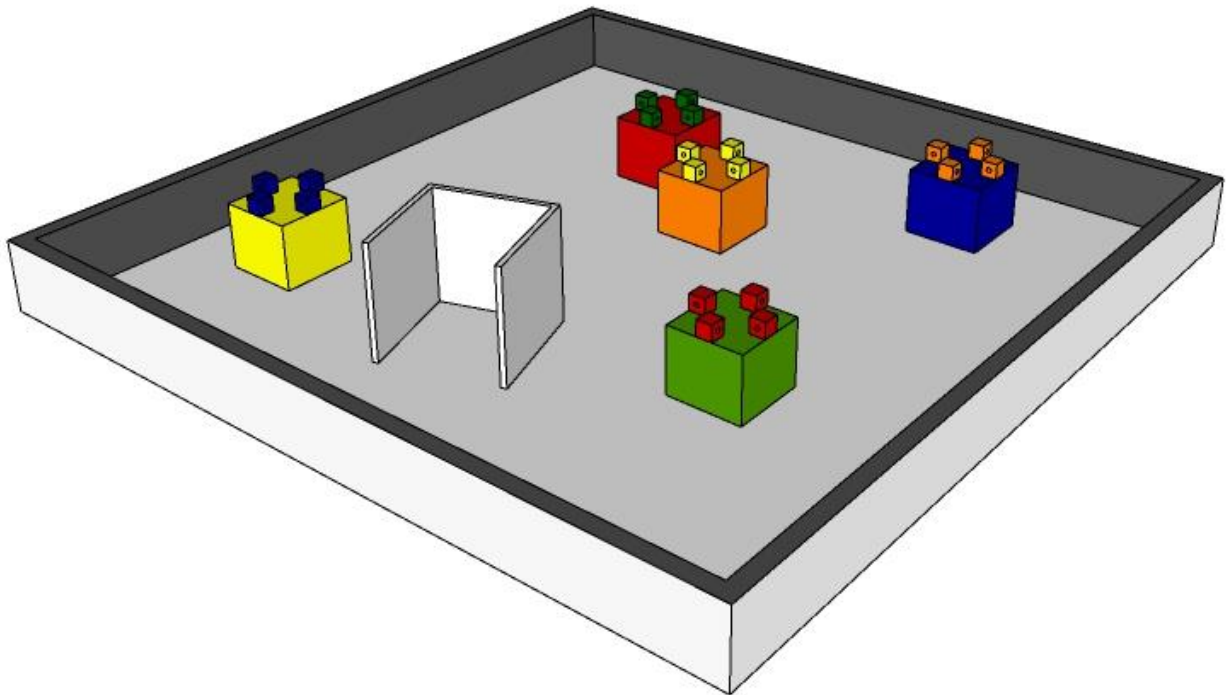

Table of Contents

1. Introduction.....	3
2. Game Description.....	4
3. Game Alternatives.....	6
4. Game Rules.....	10
5. Scoring.....	12
6. Field Specification.....	16
7. Appendix A.....	28
8. Appendix B.....	29
9. Appendix C.....	34
10. Appendix D.....	38

1. Introduction

The challenge is to make a robot that can score as many points as possible in a robot version of the autonomous operation of gardening in a green house. This year the team must design and program robot that can do localization and mapping for the playground that simulate different environment of a green house in order to garden the green house.



2. Game Description

A greenhouse is a closed structure that provide different regulated climate for plants. The greenhouse is represented by open square table. The greenhouse contains plants in the growth stage which are represented by small cubes laying on the top of boxes. The boxes represent different climate which differs in the illumination and warming conditions. There are 5 boxes of 5 different colors and on top of each box there are 4 small cubes which not from the same color of the box and they are located in the four known direction (right, left, forward and backward). The boxes do not have a fixed position inside the table. The robot must start from a parking zone represented by white box that have open side. Figure 1 shows the game field.

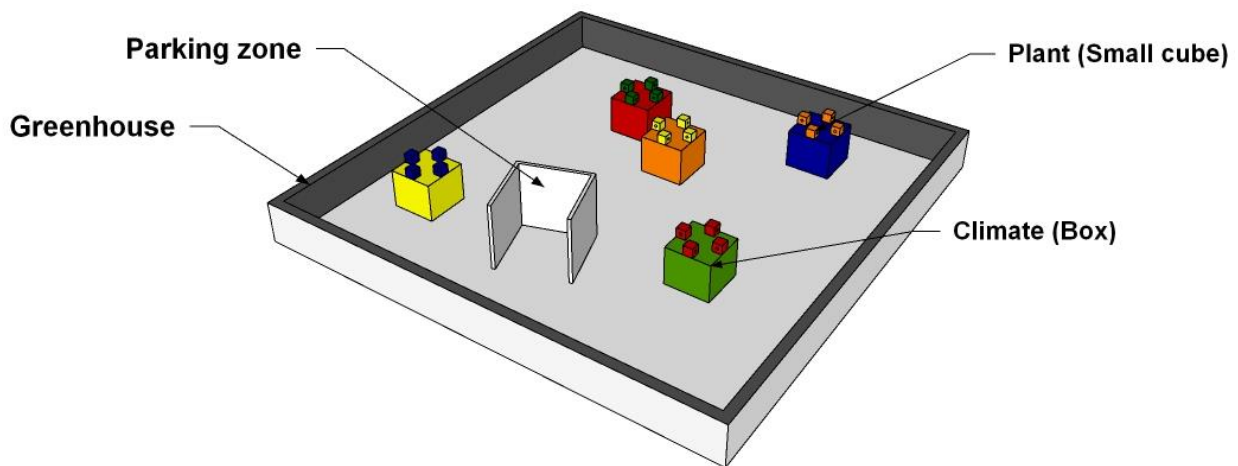

Figure 1. Detailed game field

Notice that the positions of the boxes are randomly defined during the drawing before every attempt of the round.

The robot's task is to move some plants from climate to another one which is represented in the playground as moving the small cubes from top of the boxes to another one.

The robot should identify only three needed cubes on the boxes by the following rules and move them to another box:

1. The first cube is located always on the blue box on that side of the box which is the opposite side to the side which is facing the closest wall.

2. The color of the cube on the blue box identifies the second box. So, the first cube should be moved to this box.
3. The second cube is located on the second box on that side of the box which is the opposite side to the side which is facing the closest wall.
4. The color of the cube on the second box identifies the third box. So, the second cube should be moved to this box.
5. The third cube is located on the third box on that side of the box which is the opposite side to the side which is facing the closest wall.
6. The third cube must be moved to the parking box (could be on top of or within the robot).

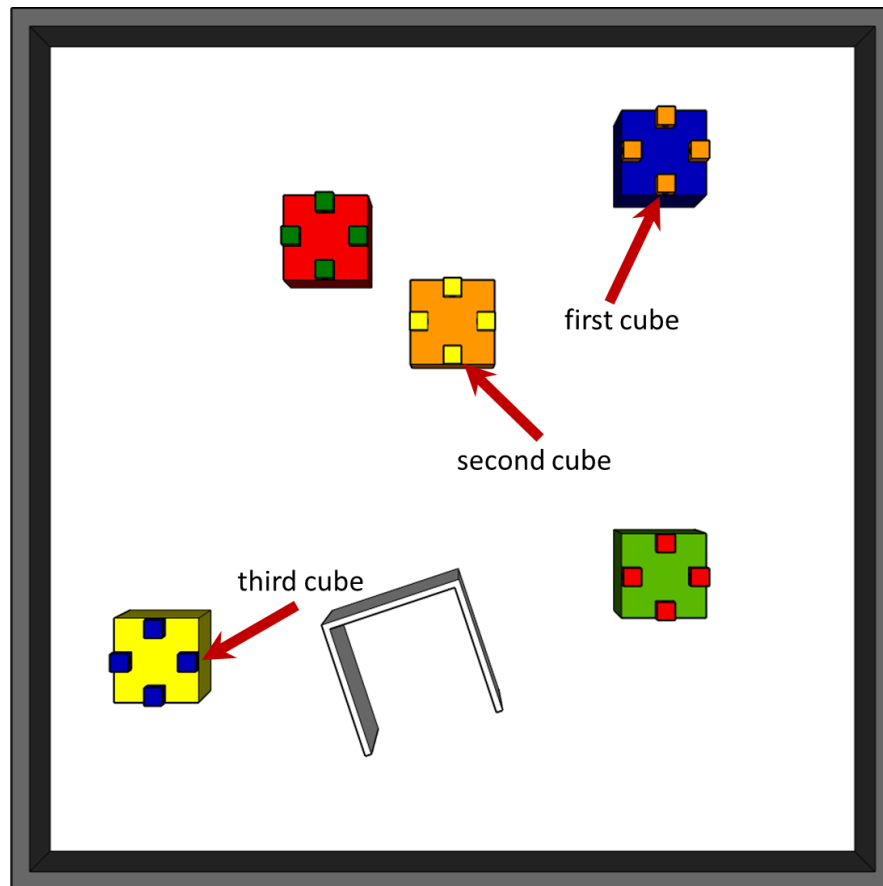

Figure 2. Cubes that need to be handled.

3. Game Alternatives

There are two types of matches: qualifying matches and final matches.

For the International Final it will be held: 3 qualifying matches and 2 final matches.

During **qualifying matches**, there will be 4 QR-codes which will be provided and all of them are identical and has the correct coordinates for the game elements, refer to **figure 14**. The QR-codes will be located on the inner side of the parking box in order to make the robot able to scan it. This QR-codes will have specific text form which will allow to identify the position and the direction of the parking box and the coordinates of all the boxes (without their colors) in the following form:

$(X_{p1}, Y_{p1}, X_{p2}, Y_{p2}) (X_1, Y_1, X_1, Y_1) (X_2, Y_2, X_2, Y_2) (X_3, Y_3, X_3, Y_3) (X_4, Y_4, X_4, Y_4) (X_5, Y_5, X_5, Y_5)$.

X_{p1}, Y_{p1} : the coordinates of the upper-right point of the inner edge of the parking zone.

X_{p2}, Y_{p2} : the coordinates of the lower-right point that lies on the inner edge of the parking zone. Refer to **figure 20** for details.

X_i, Y_i : the coordinates for one of the corner points for one of the boxes in the field.

X_i, Y_i : the coordinates for the opposite corner point for the same box which is identified by the previous coordinates X_i, Y_i .

Such that $1 \leq i \leq 5$.

Notice that the coordinates of the needed boxes are not necessary to be ordered in the same order of the task (i.e. (X_1, Y_1, X_1, Y_1) is not necessary to be the coordinates for the first needed box). Also, X_1, Y_1 is not necessary to be the coordinates for the upper-left point of the box. Refer to **figure 6** for details.

The coordinates are represented by English letters from A to U which represent crosses of a grid on the playground.

There are no space characters in the text coding position of needed boxes.

The QR-code is generated as per description of algorithm available on <https://www.thonky.com/qr-code-tutorial/>.

See **figure 4** and **figure 9** for more illustration.

Examples of location of game elements and corresponding QR-codes can be found in the Appendix C.



**Figure 3. QR Code represents the text
“(J,J,K,H)(S,I,U,K)(T,L,R,N)(S,O,Q,Q)(F,F,D,H)(N,R,P,T)”
(generated by <https://www.thonky.com/qrcode/>)**

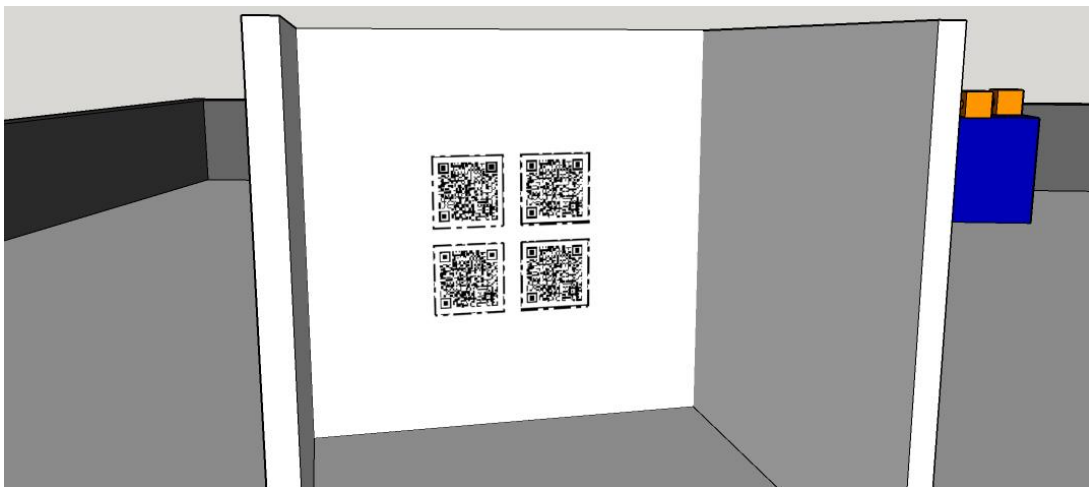

Figure 4. Four identical QR-codes within the parking box for the qualification matches.

During **final matches**, there will be 4 different QR-codes which will be provided and only one of them has the correct coordinates for the game elements, however, the coordinates of the parking zone will be the same and correct in the 4 QR-codes. The QR-codes will be located on the inner side of the parking box in order to make the robot able to scan it, for the exact places for the QR-codes in the parking zone, refer to **figure 14**.

The format of a single QR-code is in the following form:

$(X_{p1}, Y_{p1}, X_{p2}, Y_{p2}) (X_1, Y_1, X_1, Y_1) (X_2, Y_2, X_2, Y_2) (X_3, Y_3, X_3, Y_3) (X_4, Y_4, X_4, Y_4) (X_5, Y_5, X_5, Y_5)$.

X_{p1}, Y_{p1} : the coordinates of the upper-right point of the inner edge of the parking zone.

X_{p2}, Y_{p2} : the coordinates of the lower-right point that lies on the inner edge of the parking zone. Refer to **figure 20** for details.

X_i, Y_i : the coordinates for one of the corner points for one of the boxes in the field.

X_i, Y_i : the coordinates for the opposite corner point for the same box which is identified by the previous coordinates X_i, Y_i .

Such that $1 \leq i \leq 5$.

Notice that the coordinates of the needed boxes are not necessary to be ordered in the same order of the task (i.e. (X_1, Y_1, X_1, Y_1) is not necessary to be the coordinates for the first needed box). Also, X_1, Y_1 is not necessary to be the coordinates for the upper-left point of the box. Refer to **figure 6** for details.

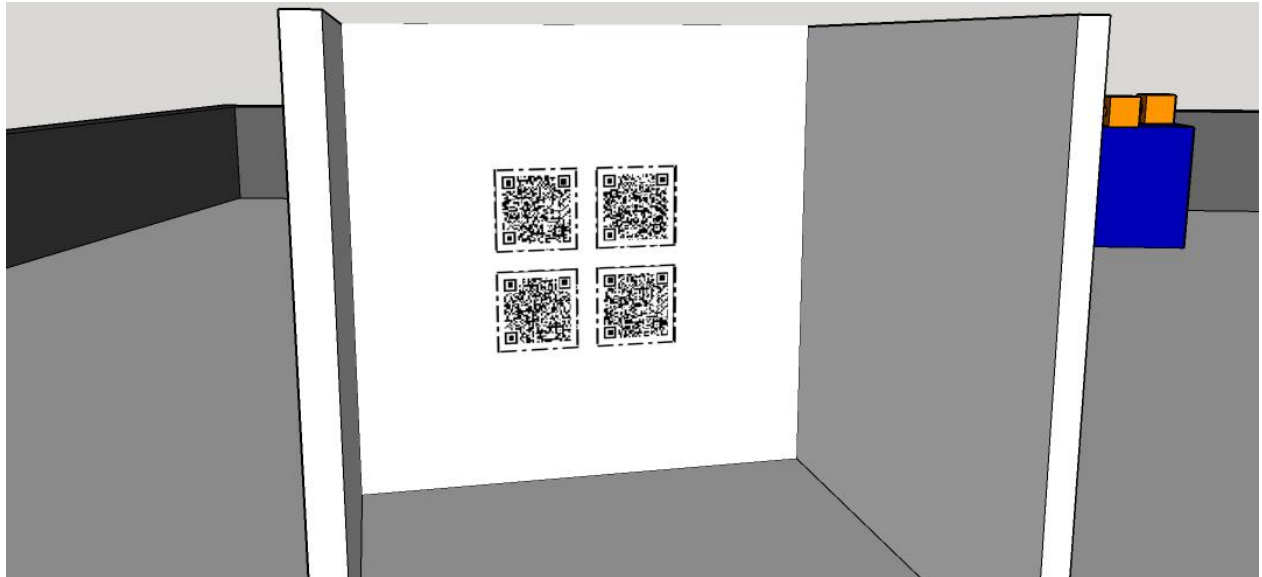

Figure 5. Four different QR-codes within the parking box for the final matches.

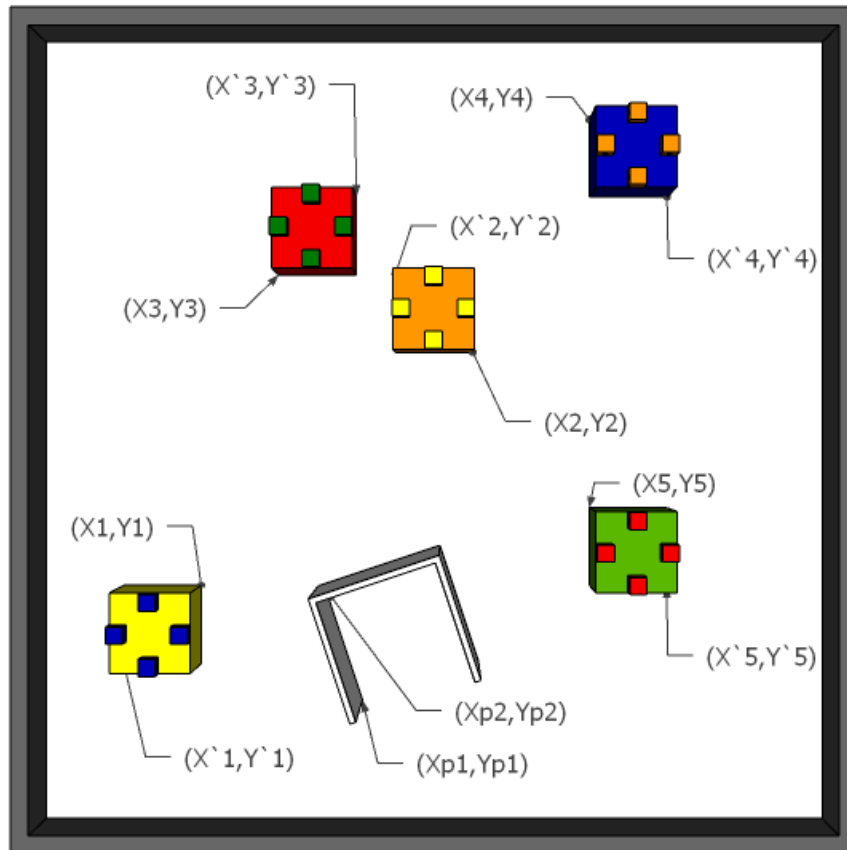

Figure 6. Illustration for the meaning of the coordinates coded in the QR-code.

4. Game Rules

Match Timing:

- Every qualifying match is three minutes in length.
- Every final match is five minutes in length.

Starting Configuration:

- The positions of the boxes and the parking zone are unknown before the starting of the round. The positions are selected randomly by the judges before the start of the round but it is assured that the boxes will be parallel to the wall of the table. But the parking zone not necessary to be parallel to the table's wall; See **Appendix A** and **Appendix B** to see the possible orientations of the boxes and the parking box respectively.

The special web-application accessible on <https://arc.wro-association.org> will be provided to simplify the procedure of drawing.

- The positions of the boxes and the parking zone are the same for all teams during the same round.

Match Start:

- The robot must start from the parking zone which means the robot should be inside the parking zone and no part of the robot is allowed to be outside of the parking box in the starting time.
- The robot's dimensions must not exceed 345 x 345 x 345 mm in the starting (cables are allowed to be outside of this size) but it can exceed the dimensions in width and length but not the height during the round.
- The match timer starts when the judge gives the signal to start.

Additional Pieces:

- The robot must not leave additional pieces on the game field nor leave marks that are not removable (e.g. paint) during the match intentionally. If the robot violates this rule, the round will be stopped and the robot must be stopped by one of the team's members and the score for this round will be zero. The judges have the right to inspect the team's code if they suspected in such a situation.

During the Match:

- The robot is not allowed to move the boxes neither nor the parking zone. Moreover, if the robot violates this rule during its round, the attempt will not be stopped but the robot will get zero score for this round. The box is considered to be moved from the initial position if one of box's corners is farther than 10 mm from the cross where it was located before the robot started.
- The robot is allowed to move cubes from one box to another in any order.
- The robot is allowed only to move the needed cubes which are described in the game description.
- The robot should not move other cubes.
- The robot must return to the parking zone to get additional points.

Match End:

- The match ends and time is stopped if any of the following conditions occurs:
 - The match timer expires
 - Any team member touches the robot
 - Any team member touches the field mat, wall or the game elements
 - The robot places a cube outside of the game field or drives outside of the game field.
 - The robot or team member damages the field or a game element (box, cube)
 - The projection of the robot is completely the parking zone (cables can be outside)
- Notice that, according to the above rules: the team can stop their attempt (e.g. by touch the field wall or do any of the above rules). However, they will not be able to resume the attempt after the stop and the match will be ended.

5. Scoring

The official score will be calculated at the end of each round.

The maximum score depends on the type of round:

- Qualifying round is 95 points
- Final round is 190 points

In the score table, there are **three main** types of the cube location:

- If the cube's projection is completely within the grey zone on top of the box in the placing zone – the cube is considered as completely in the zone.
- The cube is considered as partially in the zone in the following cases:
 1. If any part of the cube's projection touches the white zone outside of the grey square on top of the box but there is a part of the cube's projection that is still within the grey square – the cube is considered as first degree partially in the placing zone.
 2. If any part of the cube's projection touches the black zone outside of the grey square on top of the box but there is a part of the cube's projection that is still within the grey square – the cube is considered as second degree partially in the placing zone.
 3. If any part of the cube's projection is outside the black zone on top of the box but there is a part of the cube's projection that is still within the grey square – the cube is considered as third degree partially in the placing zone.
- If the cube's projection is completely outside of the placing zone on top of the box – the cube is considered as completely out of the placing zone.

There are three types that describe the location of the robot within the parking box:

- If the robot's projection (without cables) is completely within the square formed by the projection of the parking zone – the robot is considered as completely in the parking box.

- If any part of the robot’s projection (without cables) touches the area outside of the square formed by the projection of the parking zone but there is a part of the robot’s projection that is still within the square – the robot is considered as partially in the parking box.

There are illustrations about “in the zone”, “partially in the zone” and “out of the zone” in the **Appendix D**.

	Requirements	Qualifying rounds		Final rounds	
		Point value	Total Available	Point value	Total Available
1.	Picking the cube. Only boxes from 2.1, 2.3 and 2.5 of Game Description are being taken into account.				
1.1.	The cube initially located on required side of required box is completely out of the zone. Other three cubes on this box are completely within the zones they were placed initially.	5	15	10	30
1.2.	The cube initially located on wrong side of required box is completely out of the zone. Other three cubes on this box are completely within the zones they were placed initially.	1	3	2	6
1.3.	Any cube initially located on required box is partially in the zone. Other three cubes on this box are completely within the zones they were placed initially.	0	0	0	0
1.4.	At least two cubes initially located on required box are partially in the zone or completely out of the zone.	0	0	0	0
2.	Placing the cube. The color of the cube matches the color of the box. Only boxes from 2.1, 2.3 and 2.5 of Game Description are being taken into account.				
2.1.	The cube is on required side of the box and completely within the grey zone. There is no another cube that is completely within or partially in the same placing zone. Yet three cubes on this box are completely within the zones they were placed initially. Only four cubes on the box.	20	40	40	80

2.2.	The cube is on required side of the box and first degree partially in the placing zone. There is no another cube that is completely within or partially in the same zone. Yet three cubes on this box are completely within the zones they were placed initially. Only four cubes on the box.	15	30	30	60
2.3.	The cube is on required side of the box and second degree partially in the placing zone. There is no another cube that is completely within or partially in the same zone. Yet three cubes on this box are completely within the zones they were placed initially. Only four cubes on the box.	10	20	20	40
2.4.	The cube is on required side of the box and third degree partially in the placing zone. There is no another cube that is completely within or partially in the same zone. Yet three cubes on this box are completely within the zones they were placed initially. Only four cubes on the box.	5	10	10	20
2.5.	The cube is on required side of the box and completely within or partially in the zone. There is another cube that is completely within or partially in the same zone. Yet three cubes on this box are completely within the zones they were placed initially.	2	4	4	8
2.6.	The cube is on wrong side of the box and completely within or partially in the zone. There is no another cube that is completely within or partially in the same zone. Yet three cubes on this box are completely within the zones they were placed initially. Only four cubes on the box.	2	4	4	8
2.7.	The cube is on wrong side of the box and completely within or partially in the zone. There is another cube that is completely within or partially in the same zone. Yet three cubes on this box are completely within the zones they were placed initially.	2	4	4	8

2.8.	The cube is on the box (the side does not matter) and completely within or partially in one zone. There is, at least, one more cube on the same box that is completely outside or partially in another zone.	0	0	0	0
2.9.	The cube is on the box (the side does not matter) and completely within or partially in the zone. Moreover, the cube orientation of is rotated 90 degrees from the initial position where it was placed on the previous box such that the hole will be directed to the up, refer to figures 33, 34, 35 and 36.	5	10	10	20
3.	Taking the cube into the parking zone.				
3.1.	The projection of the cube picked from the third box (2.5 of Game Description, but the side does not matter) is completely within the square formed by the projection of the parking zone.	10	10	20	20
4.	Bonus. The first, second and third boxes are from 2.1, 2.3 and 2.5 of Game Description				
4.1.	There are only three cubes of the same color on the first box. There is one cube of the same color as the second box on the second box and it is completely within or partially in the zone. There is one cube of the same color as the third box on the third box and it is completely within or partially in the zone. Each of rest two box contains by four cubes completely within the zones they were placed initially. There is no two cubes of the same color touching the same zone on any boxes.	5	5	10	10
5.	Parking				
5.1	The robot is partially in the parking box. There is, at least, one cube that is completely out of the zone located on one of required boxes (the side does not matter). Other three cubes on this box are completely within the zones they were placed initially.	5	5	10	10
5.2.	The robot is completely within the parking box. There is, at least, one cube that is	15	15	30	30

	completely out of the zone located on one of required boxes (the side does not matter). Other three cubes on this box are completely within the zones they were placed initially.				
--	---	--	--	--	--

6. Field Specification

- Challenge's table:

- Square table (2400 x 2400 x 200 mm) (+/-5mm). 200 mm is the inner height.
- The ground's color is white, the inner wall's color is black and the outer wall's color is black.
- The wall's thickness is 50mm.
- The dimension of the grid's cell is (115 x 115 mm) (+/- 2mm).
- There are crosses on the table which help the judges to position the boxes. However, the robot will not be able to use grid crosses for line following as the thickness of the strokes is 1 mm or less. The color of strokes is light grey, PANTONE Cool Gray 5 C, RGB (177 179 179)
- There are line stripes positioned as it is illustrated in **figure 7**. The thickness and the color of the lines are the same as the crosses.
- The crosses will be indicated by the letters which will work as coordinates for the crosses to help in the process of positioning the boxes during the preparation of the round and also these are the coordinates which will be in the QR-code. See **figure 9** for more illustration.
- The robot should not use the letters to map the playground as they are proposed not to exist.

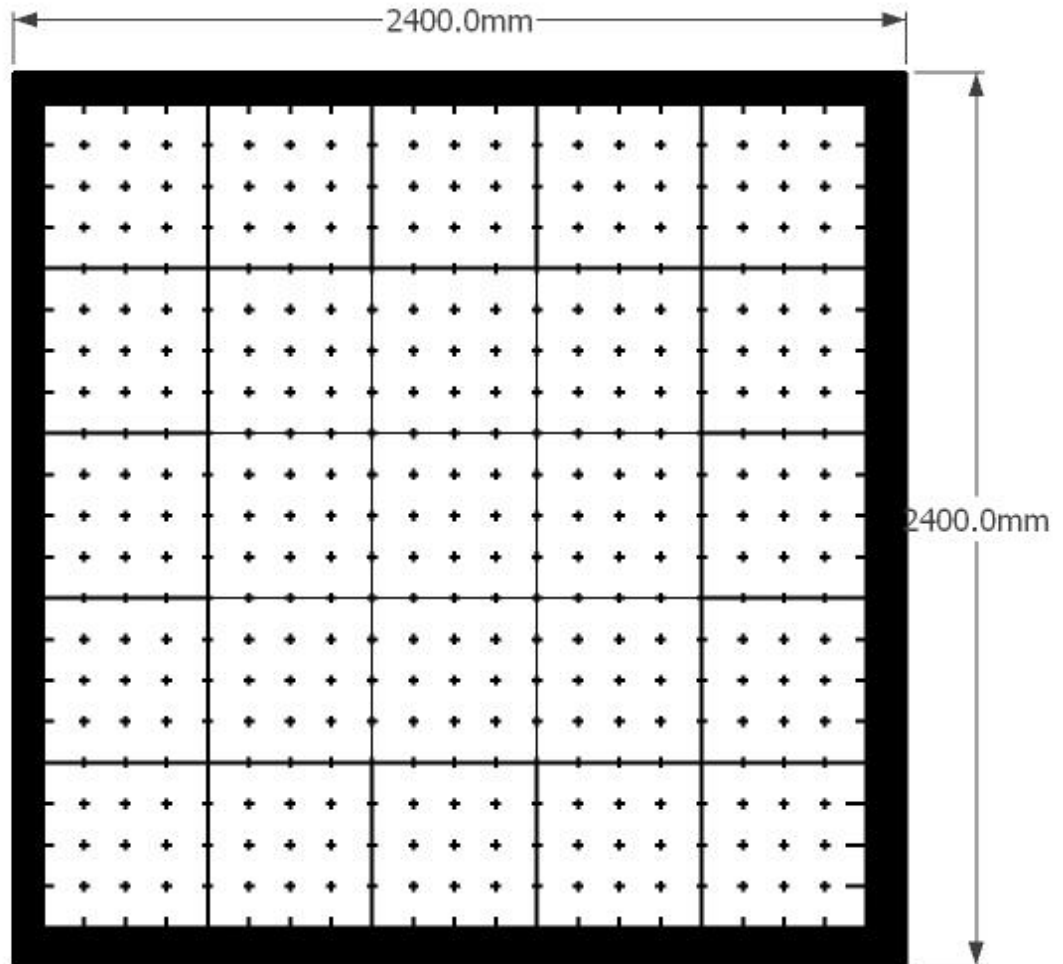

Figure 7. The dimension of the challenge's table.

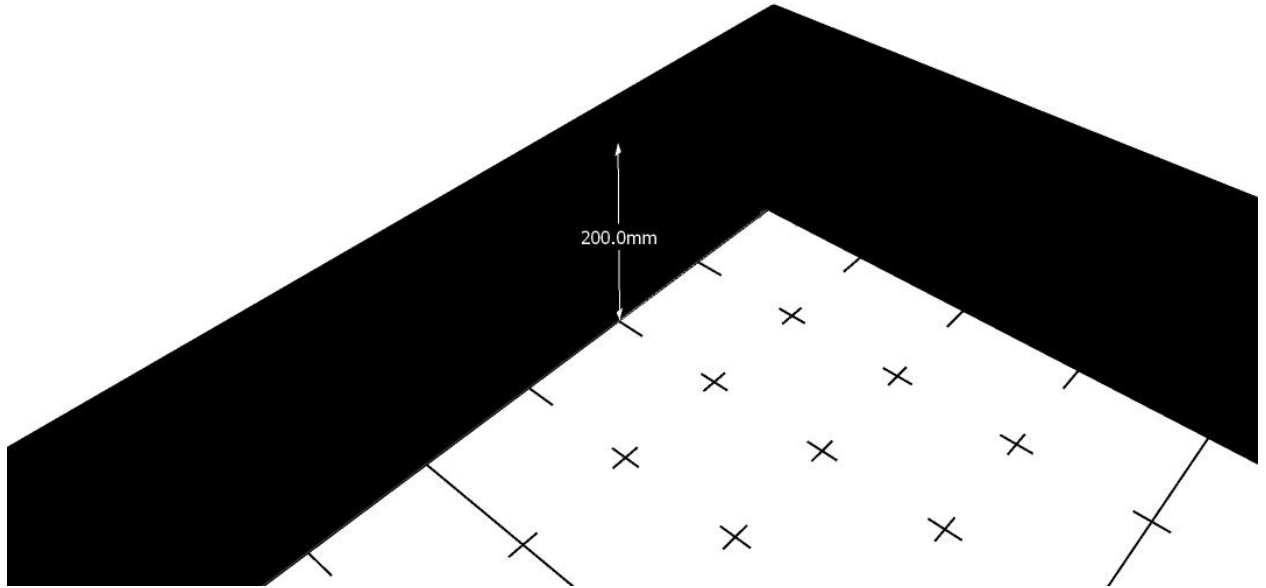

Figure 8. The inner wall's dimension.

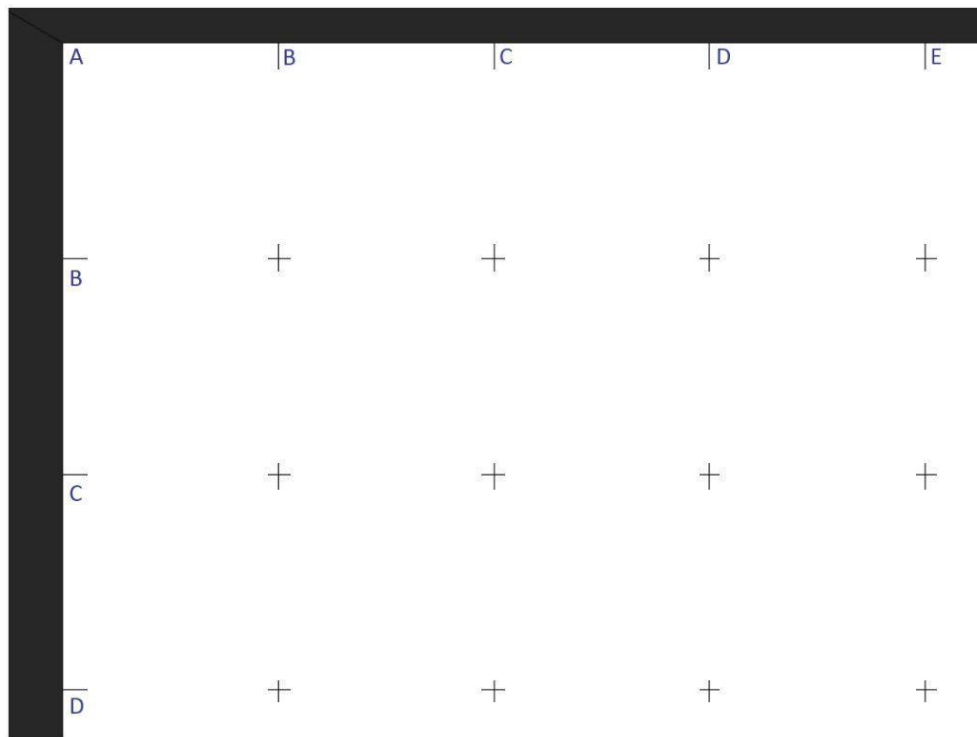

Figure 9. Illustration of the table with the letters.

- Parking zone:
 - Open side hollow cuboid (362 x 379 x 345 mm) (+/- 5mm).
 - The dimension of the inner cuboid which the robot can be there is (345 x 345 x 345 mm).
 - The parking zone's color is white.
 - The QR-code will be generated by based on the description available on <https://www.thonky.com/qr-code-tutorial/>.
 - The QR-code's dimensions are (60 x 60 mm).
 - The QR-codes in the rounds are positioned as described in **figure 14**.
 - There will be squares which will be drawn in the places of the QR-code to guide the judges to correctly place the QR-codes. However, these lines should be too thin because it is not made to guide the robot for the positions of the QR-codes.

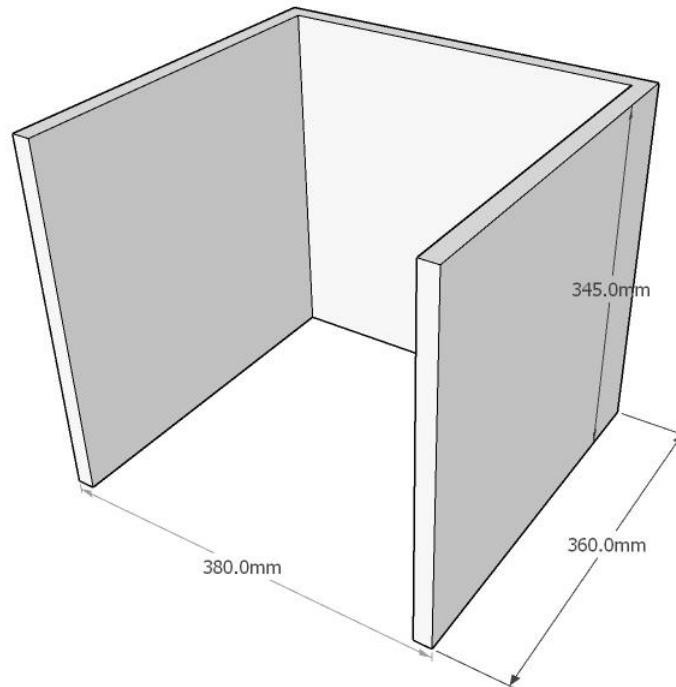

Figure 10. Dimensions of the parking zone.

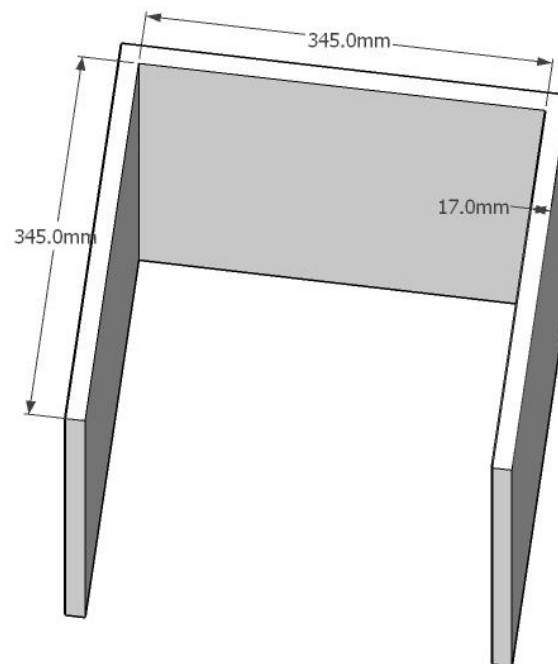

Figure 11. Inner dimensions of the parking zone.

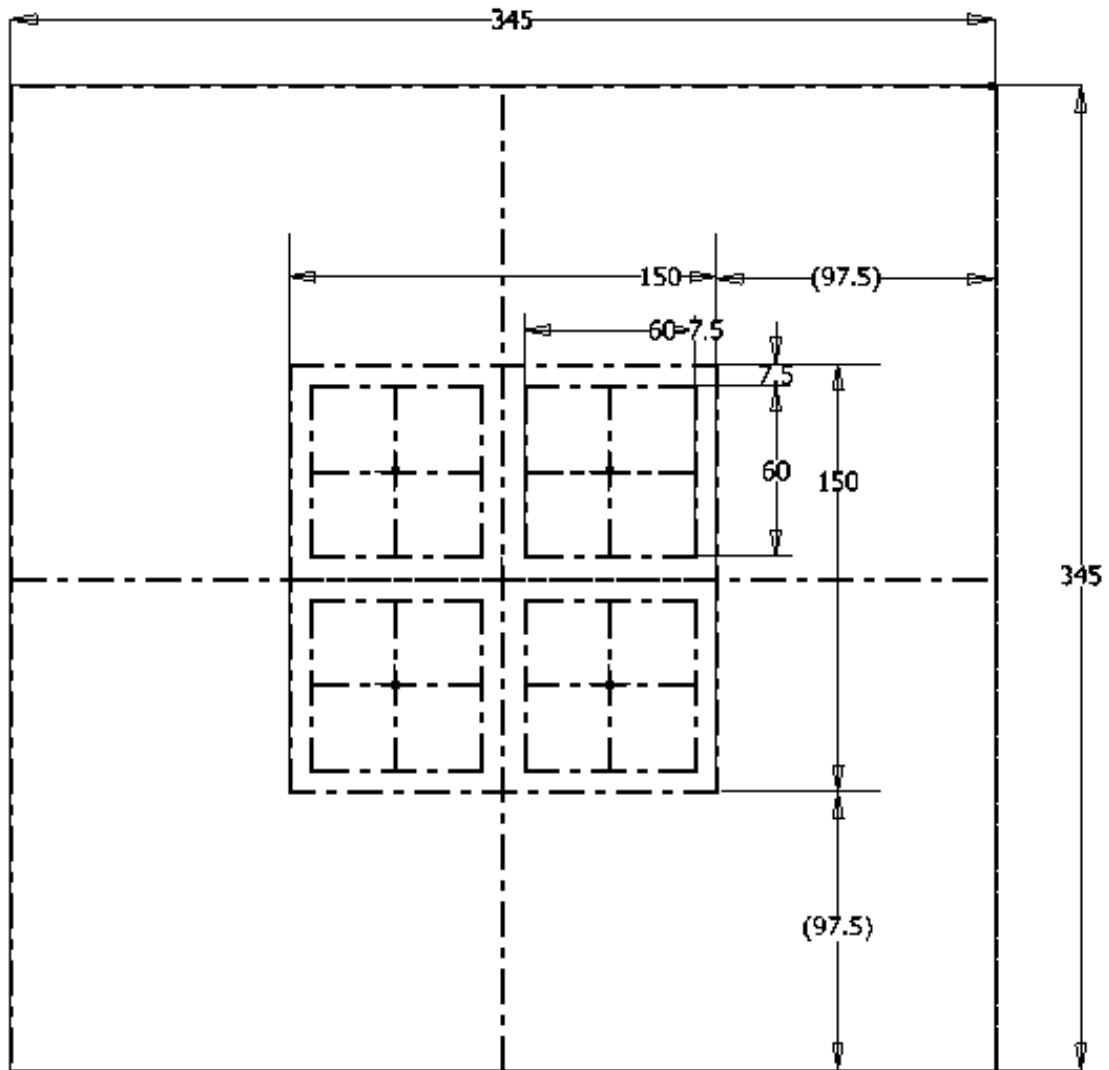

Figure 12. Exact positions of the QR-codes for the qualification and final rounds on the inner face of the parking zone.

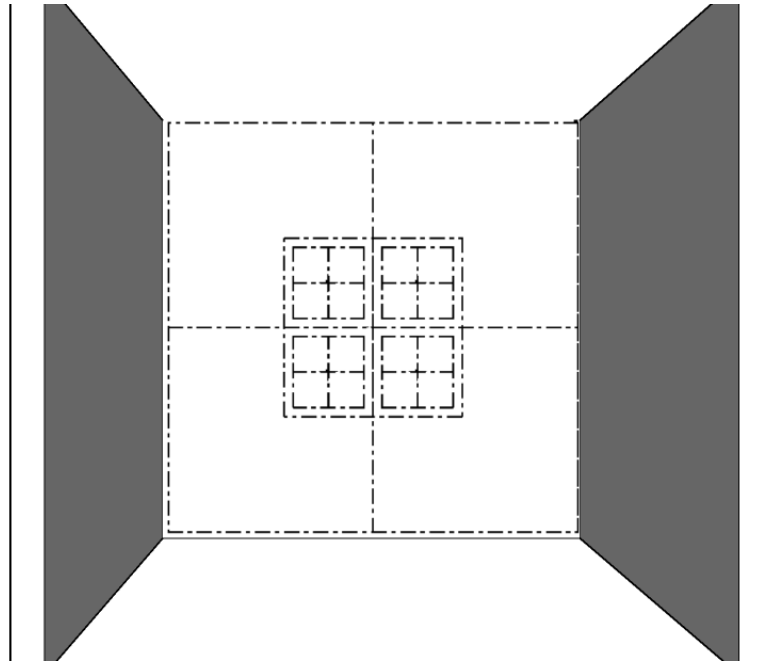

Figure 13. QR-codes' positions on the inner face of the parking zone.

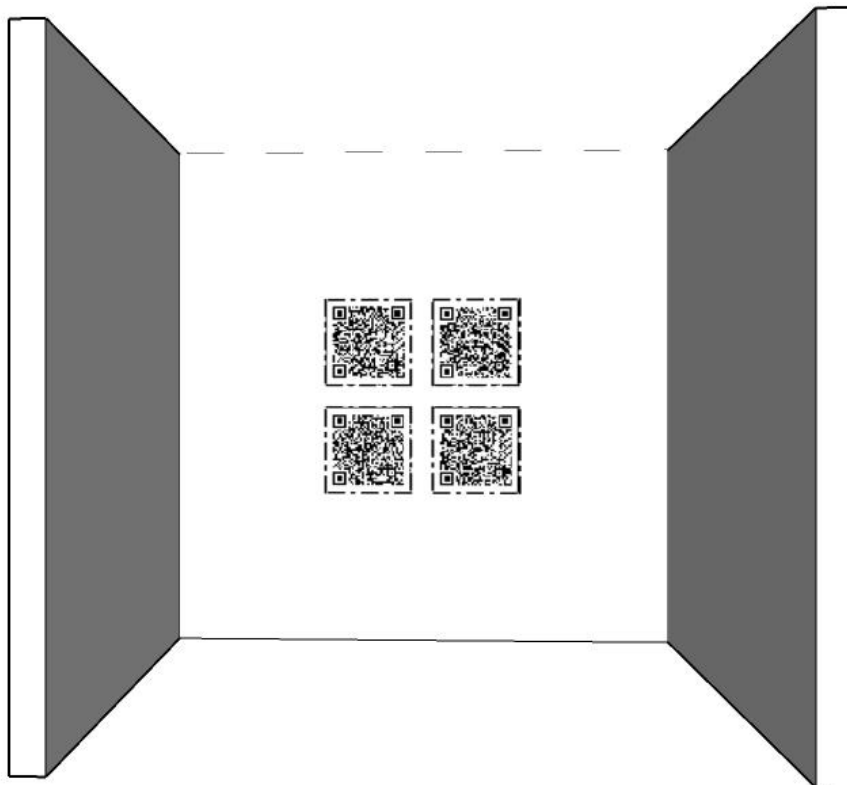

Figure 14. QR-codes on the inner face of the parking zone.

- Boxes:
 - Solid cubes (230 x 230 x 200 mm) (+/- 2mm).
 - On the table, there will be 5 boxes. The colors of the boxes are:
 - Blue, PANTONE Blue 072 C, RGB (16, 6, 159).
 - Red, PANTONE 1795 C, RGB (238, 39, 55).
 - Green, PANTONE 802 C, RGB (68, 214, 44).
 - Orange, PANTONE Bright Orange C, RGB (254, 94, 0).
 - Yellow, PANTONE 803 C, RGB (254, 233, 0).
 - The box's material is wood.
 - There are 4 squares on top of each box that indicate the places of the cubes, these squares are identified as the placing zones. Each square is defined by 3 inner zones: grey (RGB [86, 86,86]), white (RGB [255, 255,255]), black (RGB [0, 0,0]).
 - There are thin black guiding squares in the grey zone which have the same dimensions of the cubes to indicate the exact positions of the small cubes on top of the box.
 - The dimensions of the squares and zones are described in **figure 16**.
 - It is assured that the positions of the boxes which are defined by a drawing procedure will be reachable from the opposite side to the closest side to the wall. See **Appendix A** for more details.
 - Minimal difference between distances for every side of the box and the wall this side is facing to is 2300 mm.

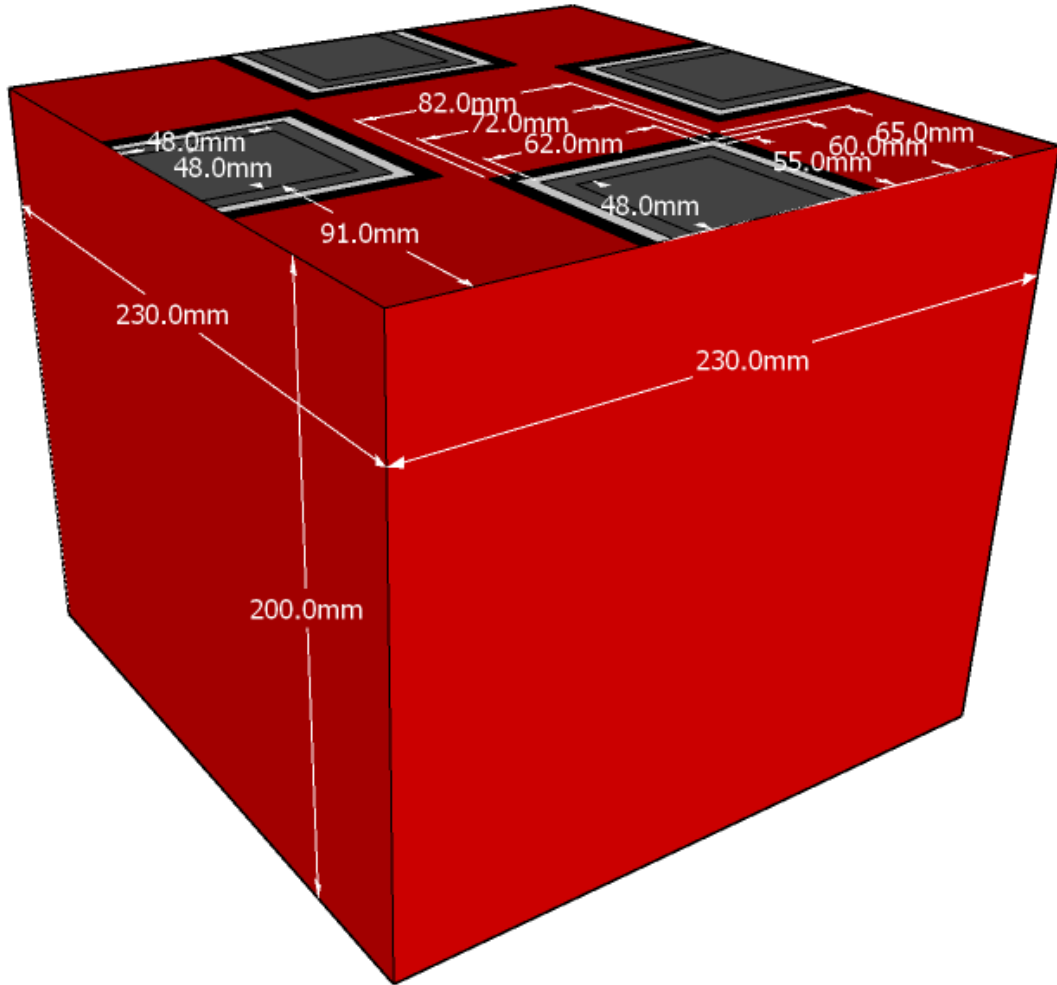

Figure 15. Box's dimensions.

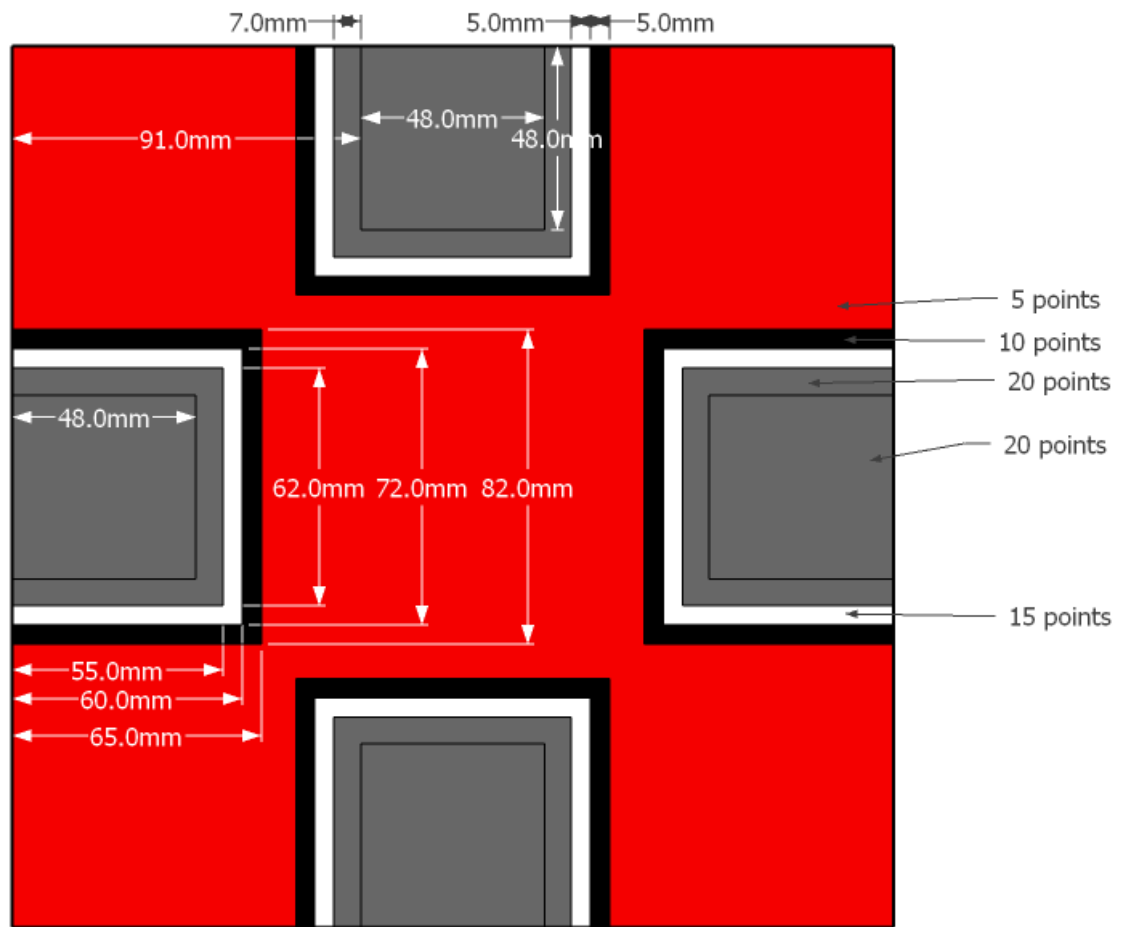

Figure 16. Illustration of cubes' positions on top of a box.

- Cubes:
 - Solid cubes (48 x 48 x 48 mm) (+/- 2mm) with hollow cylinder in the middle through the cube (Ø 15mm +/-1mm).
 - There will 4 boxes on the top of each box.
 - The colors of the cubes are:
 - Blue, PANTONE Blue 072 C, RGB (16, 6, 159).
 - Red, PANTONE 1795 C, RGB (238, 39, 55).
 - Green, PANTONE 802 C, RGB (68, 214, 44).
 - Orange, PANTONE Bright Orange C, RGB (254, 94, 0).
 - Yellow, PANTONE 803 C, RGB (254, 233, 0).
 - The cube's material is wood.
 - The dimensions of the cubes are illustrated in the **figure 17**.

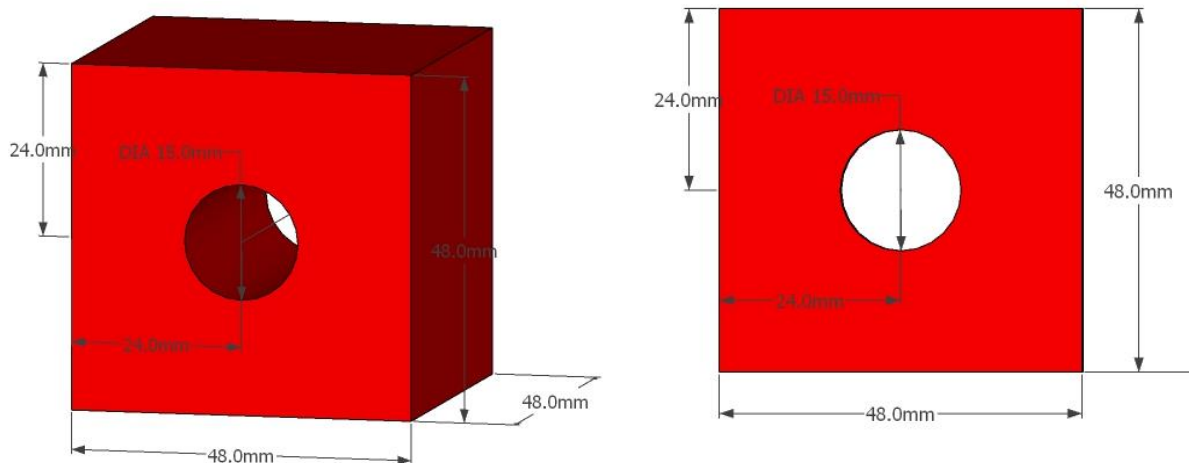

Figure 17. Cube's dimensions.

7. Appendix A

The possible positions of the boxes

- The boxes will be positioned using the crosses on the playground.
- There will be a free space in front of the side of the needed cube to ensure that it will be possible to be reached by the robot.
- The free space is a square (460 x 460 mm).
- The free space should be totally free as it doesn't contain any field items.
- The free space is not colored.

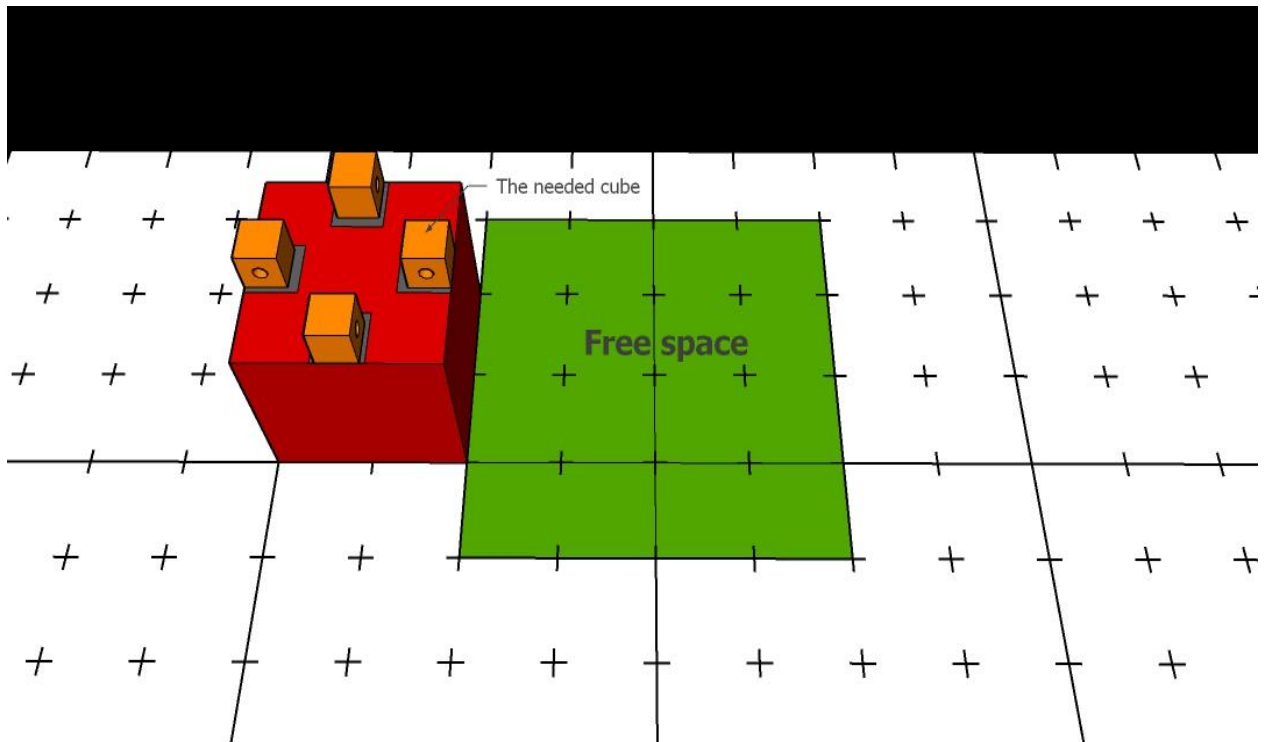

Figure 18. Right position for a Box.

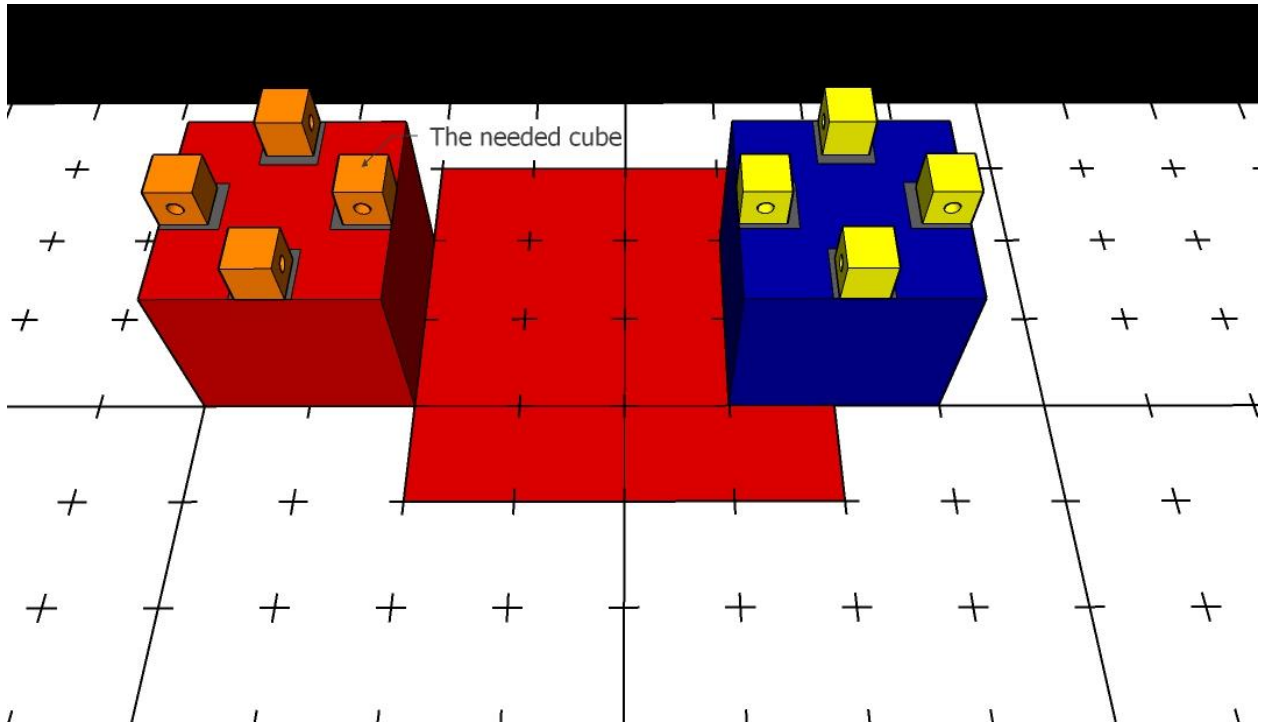

Figure 19. Wrong position for a Box.

8. Appendix B

The possible positions of the parking zone

World Robot Olympiad and the WRO logo are trademarks of the World Robot Olympiad Association Ltd.
© 2020 World Robot Olympiad Association Ltd.

- The parking zone will be positioned using the crosses on the playground.
- The position of the parking zone is not necessary to be parallel to the wall. So, it is positioned using placing the upper-right point and the lower-right inner edge point on the crosses in order to have an angle of orientation.
- It is important to note that the nearest crosses are used to draw one of 6 virtual lines. Also, the inner edge of the parking box is aligned to one of these lines. See **figure 20** for more illustration.
- There will be a free space in front of the open side of the parking zone to ensure that it will be possible for the robot to get out of the parking zone.
- The free space is an intersection of two circles (\varnothing 920 mm) which the center of the first circle is the upper-right point and the second circle is the upper-left point of the parking zone.
- The free space should be totally free as it doesn't contain any field items.
- The free space is not colored.
- The parking zone should be positioned where the robot should not see any boxes from his starting position inside the parking zone. As described in **figure 23** and **figure 24**, the yellow area is the view rays that the robot should see from the starting position in the parking zone and it is wrong to put box in this area.

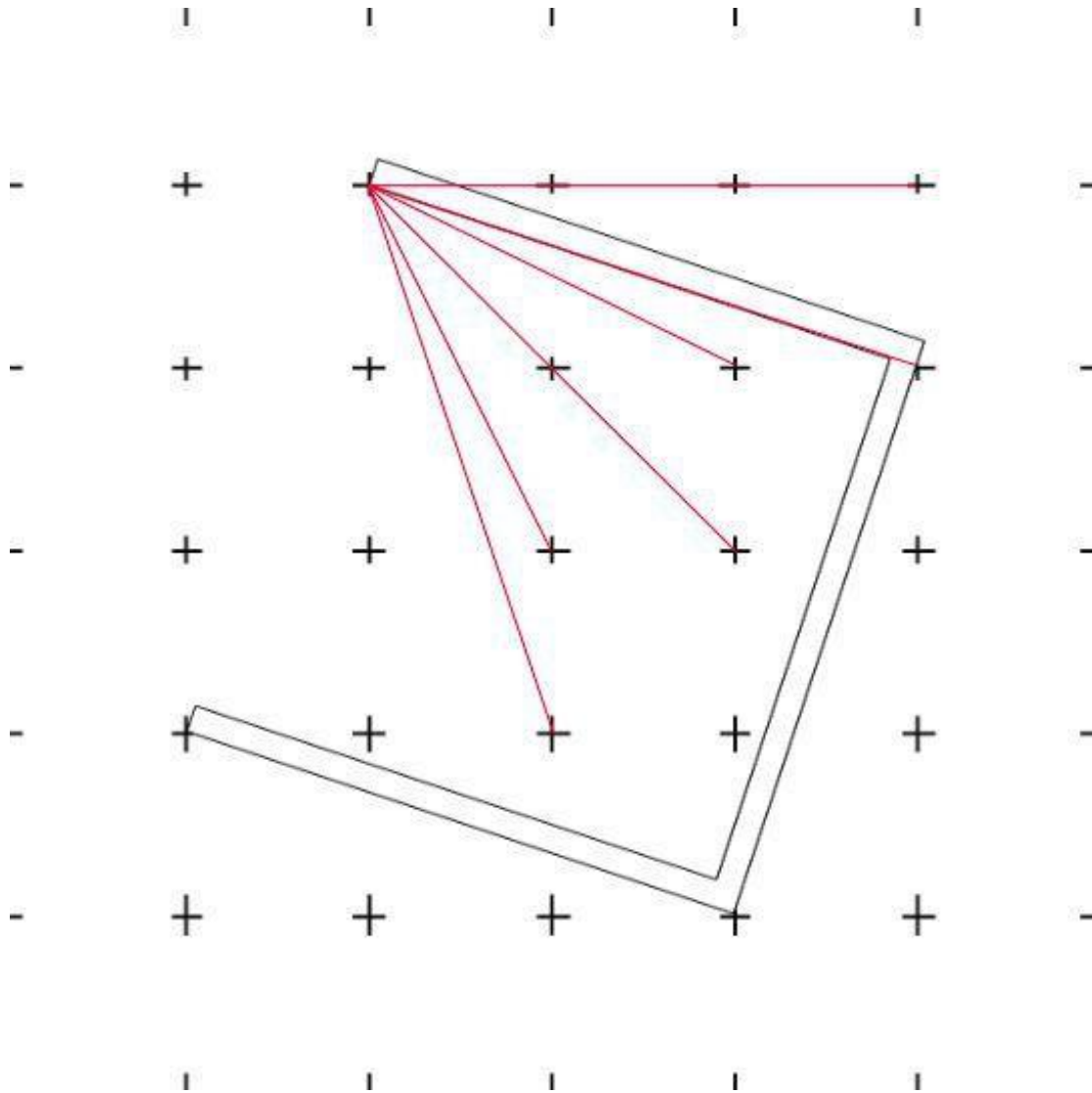

Figure 20. Illustration of position of the parking zone.

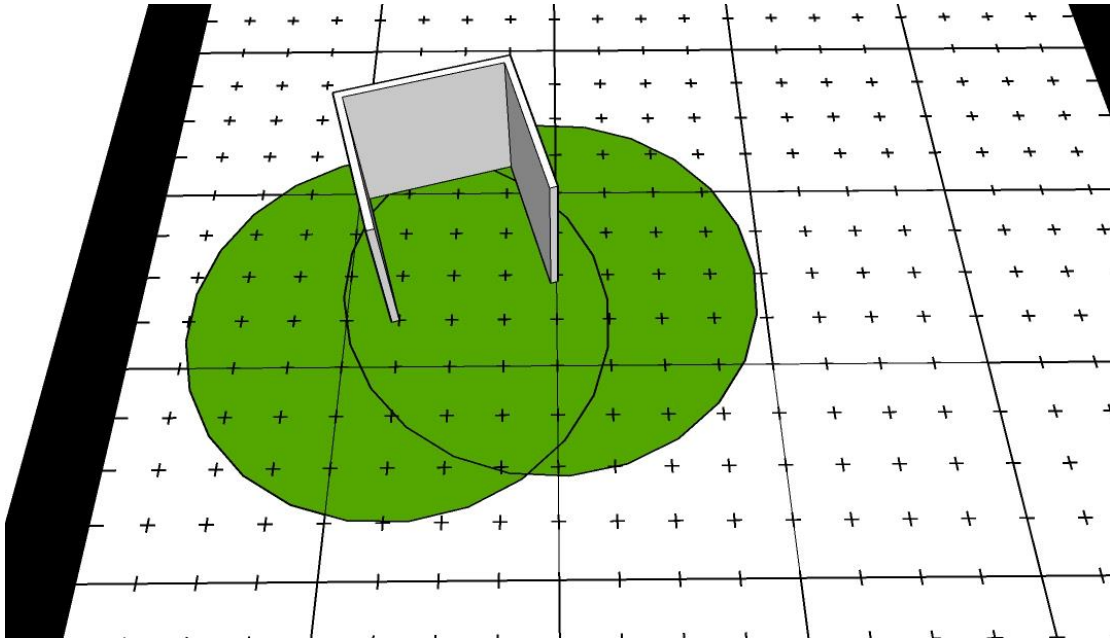

Figure 21. Right position for the parking zone.

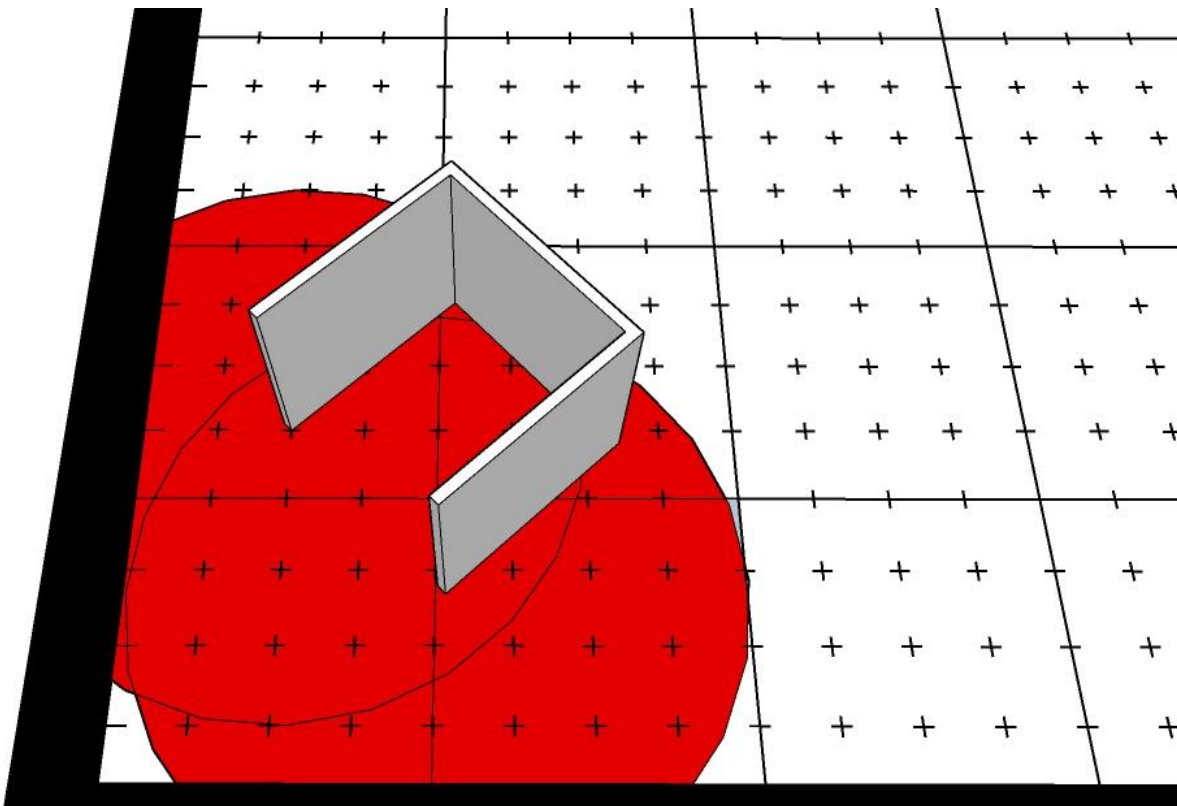

Figure 22. Wrong position for the parking zone.

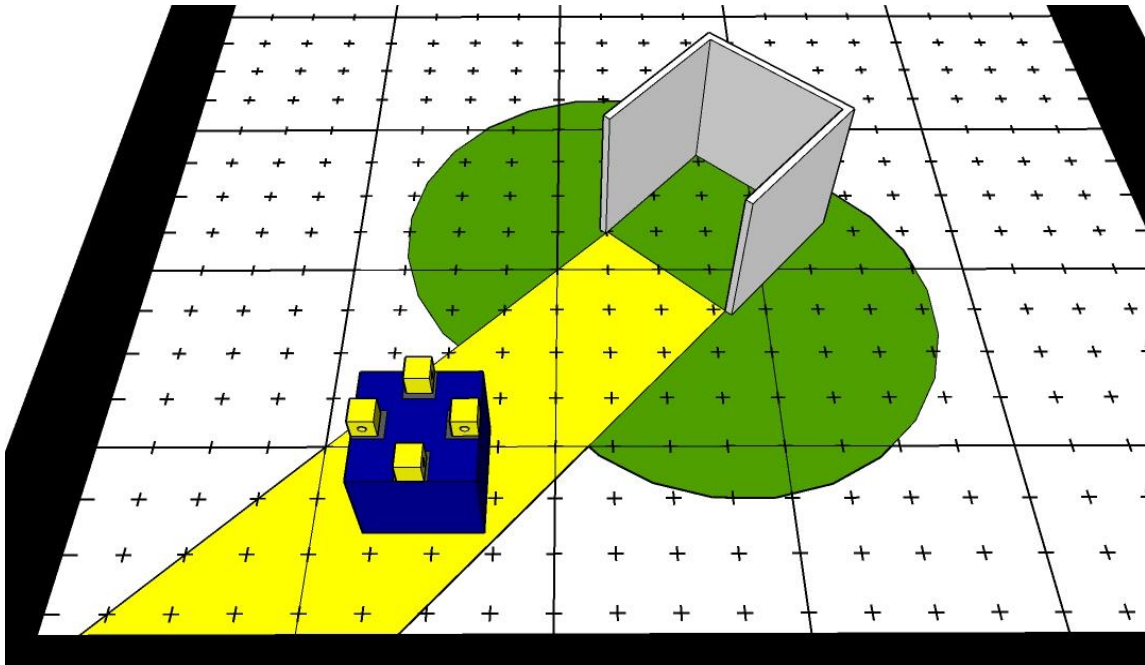

Figure 23. Wrong position for the parking zone.

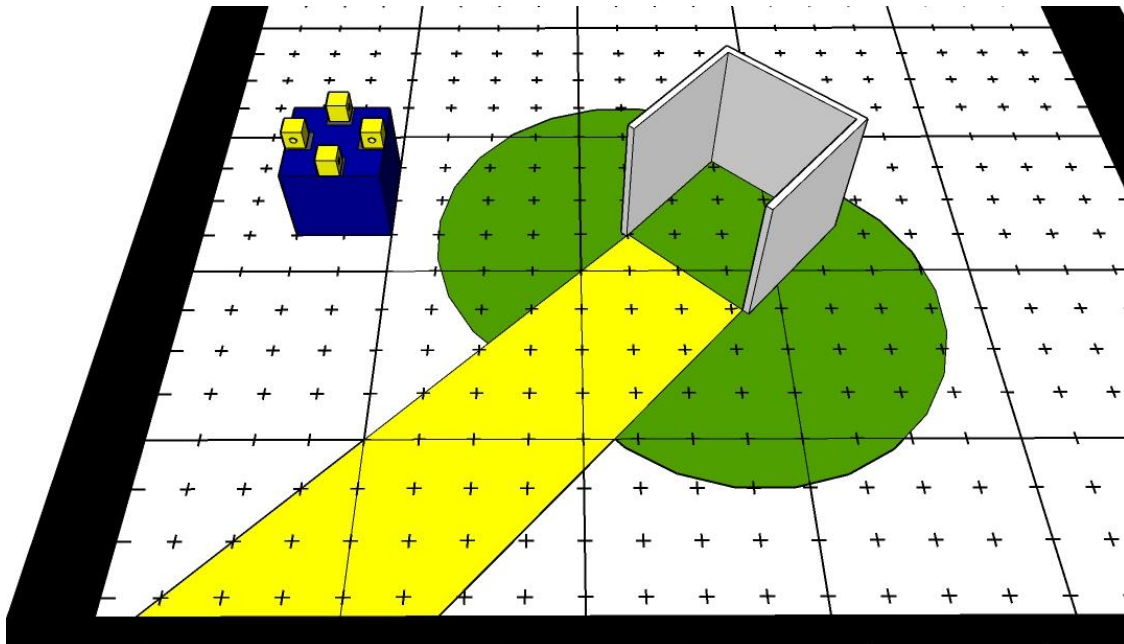

Figure 24. Right position for the parking zone.

9. Appendix C

The possible locations for game elements and the corresponding QR-codes in the Qualification rounds.

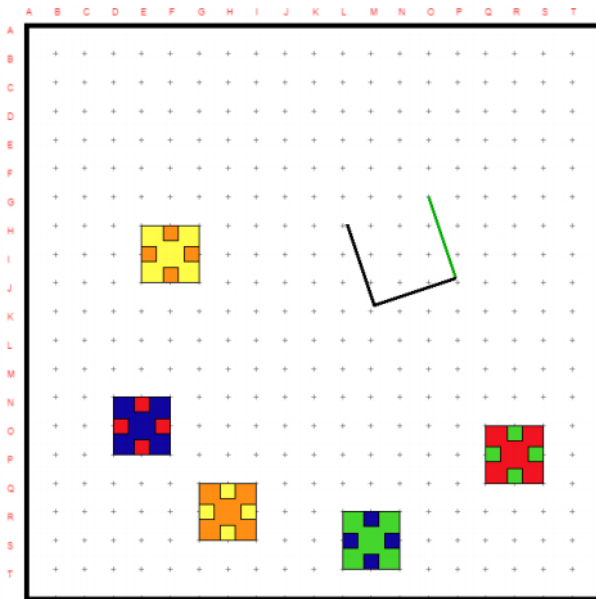

Figure 25. Locations of elements: (O,G,P,J)(E,H G,J)(D,N,F,P)(I,Q G,S)(Q,O,S,Q)(L,R,N,T).

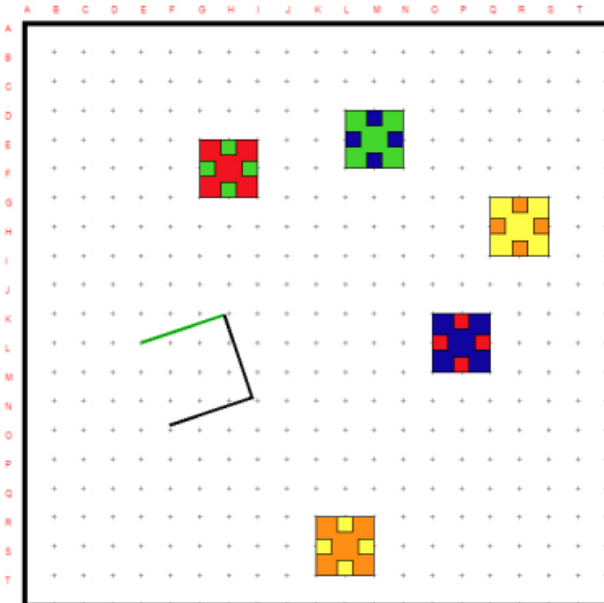

Figure 26. Locations of elements: (E,L,H,K)(L,D,N,F)(O,K,Q,M)(M,R K,T)(I,E,G,G)(S,G Q,I).

The possible locations for game elements and the corresponding QR-codes in the Final rounds.

In the following section, there are 4 QR-codes and only one of them corresponds to the correct playground in the **figure 27** and the other QR-codes are fake and they are different than the correct one. It is not necessary that the correct one will be positioned in a specific place (e.g. the upper-left corner in the place of the QR-codes) which means that the correct QR-code is randomly positioned with respect to the dimensions in **figures 12,13 and 14**. Notice that the grey squares in the **figures 28.2, 28.3 and 28.4** are considered as the fake coordinates of the boxes regardless the color of the box.

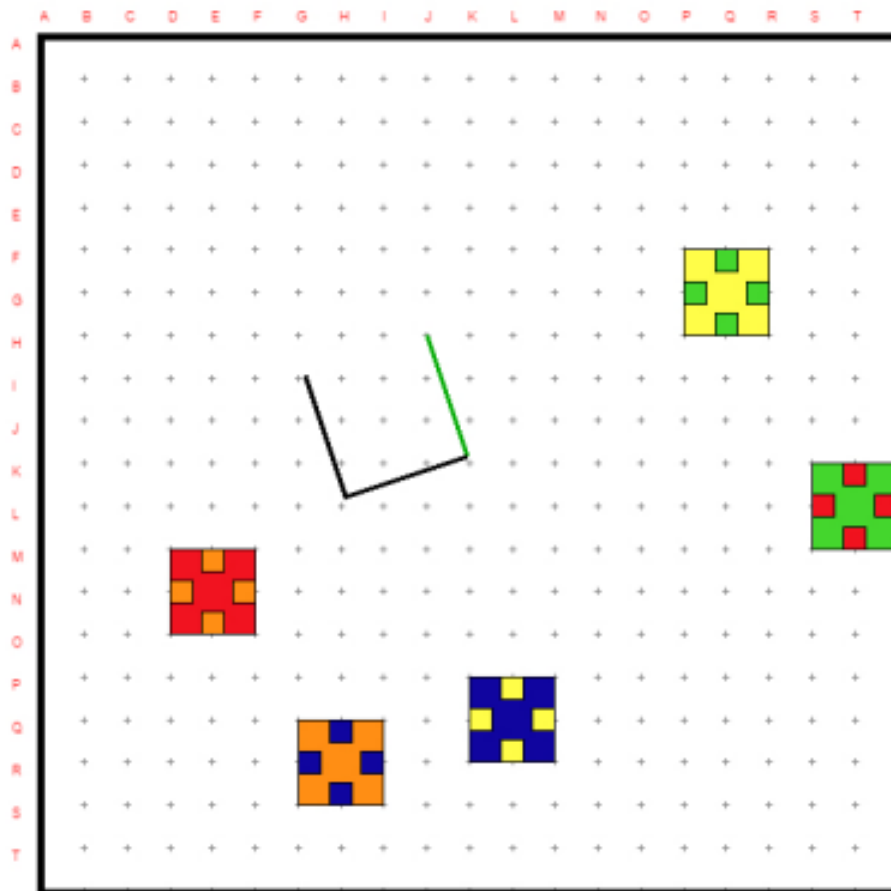

Figure 27. Correct locations of elements: (J,H,K,K)(K,P,M,R)(F,M D,O)(P,F,R,H)(S,K,U,M)(I,Q,G,S).



Figure 28.1. Correct QR-code: (J,H,K,K)(K,P,M,R)(F,M D,O)(P,F,R,H)(S,K,U,M)(I,Q,G,S)

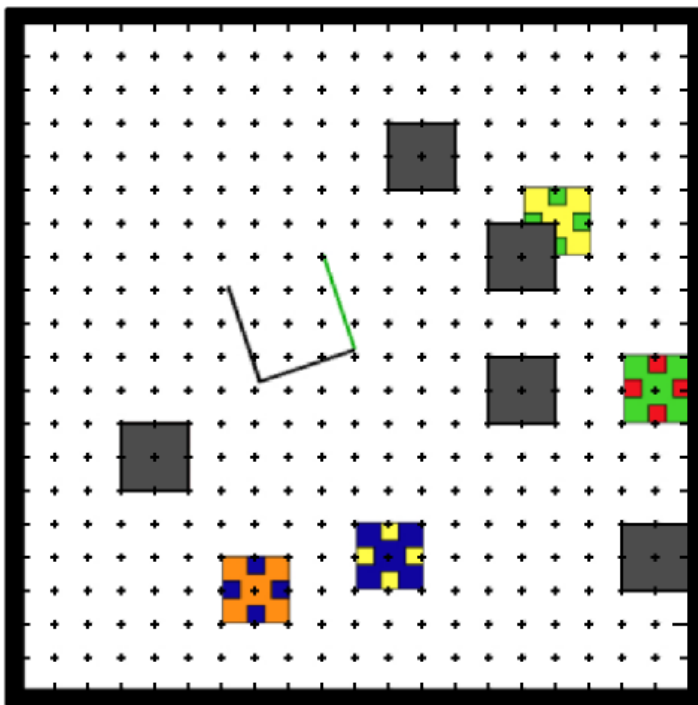

Figure 28.2. Fake QR-code: (J,H,K,K)(O,K,Q,M)(F,M,D,O)(O,G,Q,I)(L,D,N,F)(U,P,S,R)

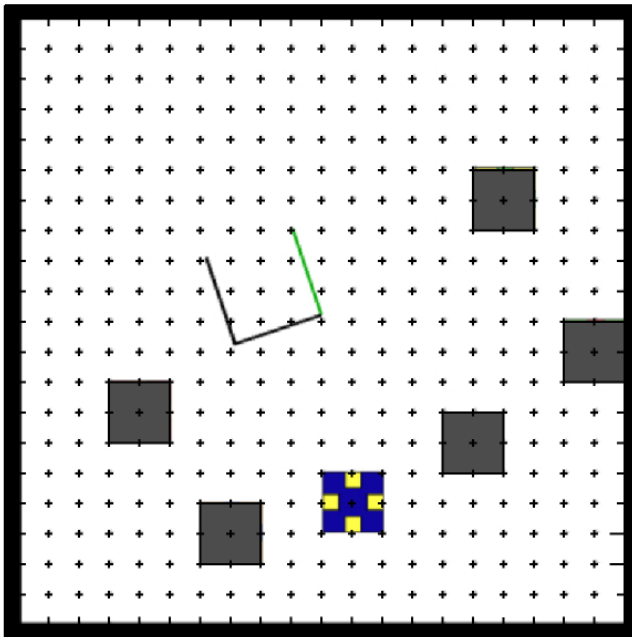

Figure 28.3. Fake QR-code: (J,H,K,K)(Q,N,O,P)(F,M,D,O)(P,F,R,H)(S,K,U,M)(I,Q,G,S)

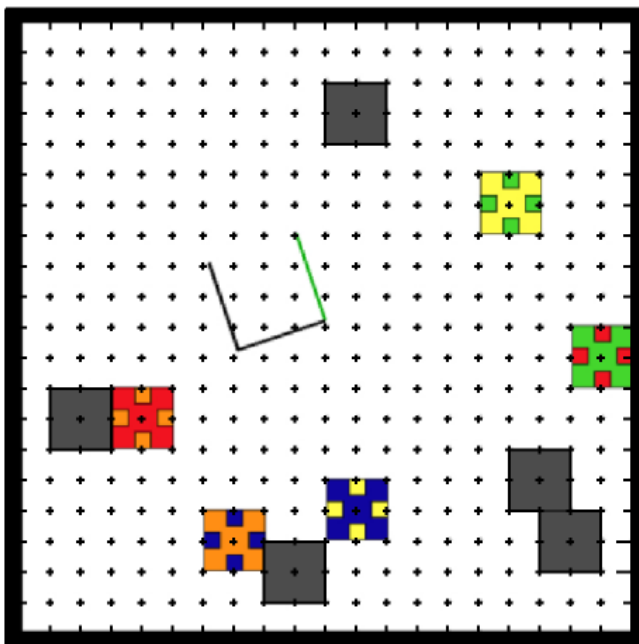

Figure 28.4. Fake QR-code: (J,H,K,K)(R,Q,T,S)(K,C,M,E)(S,O,Q,Q)(I,R,K,T)(D,M,B,O)

10. Appendix D

Cube's positions:

Completely in the zone:

The cubes are positioned perfectly in the start of the round by the judges in the black guiding squares on the top of the box.

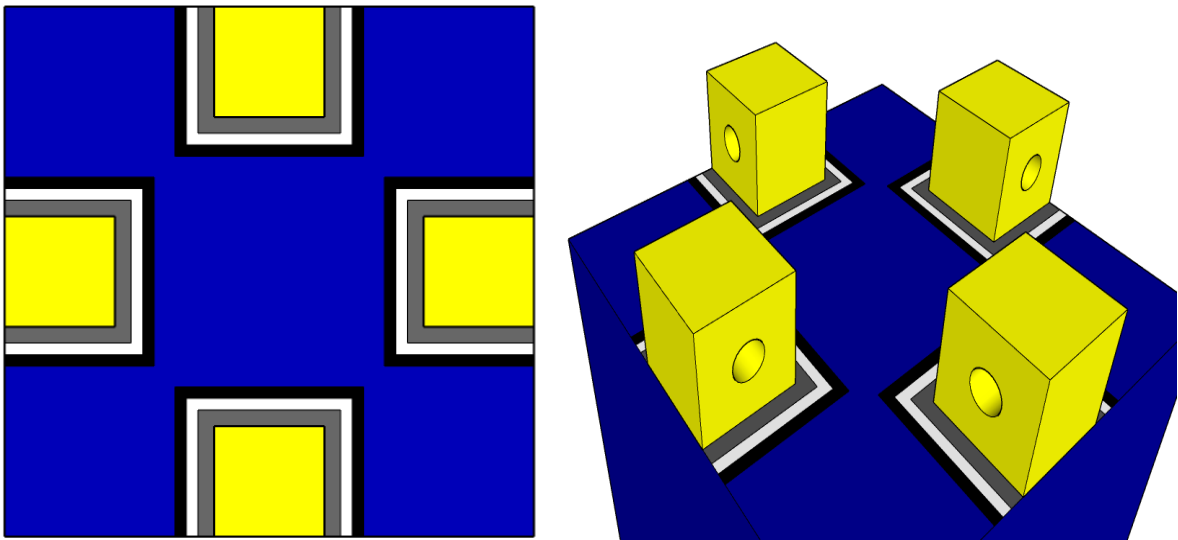

Figure 29. Cubes are perfectly positioned in the zone on top of the box.

The cube is considered positioned in the zone if the cube's projection is completely within the gray square on top of the box and no part of the cube is outside the gray square as described in the below figure.

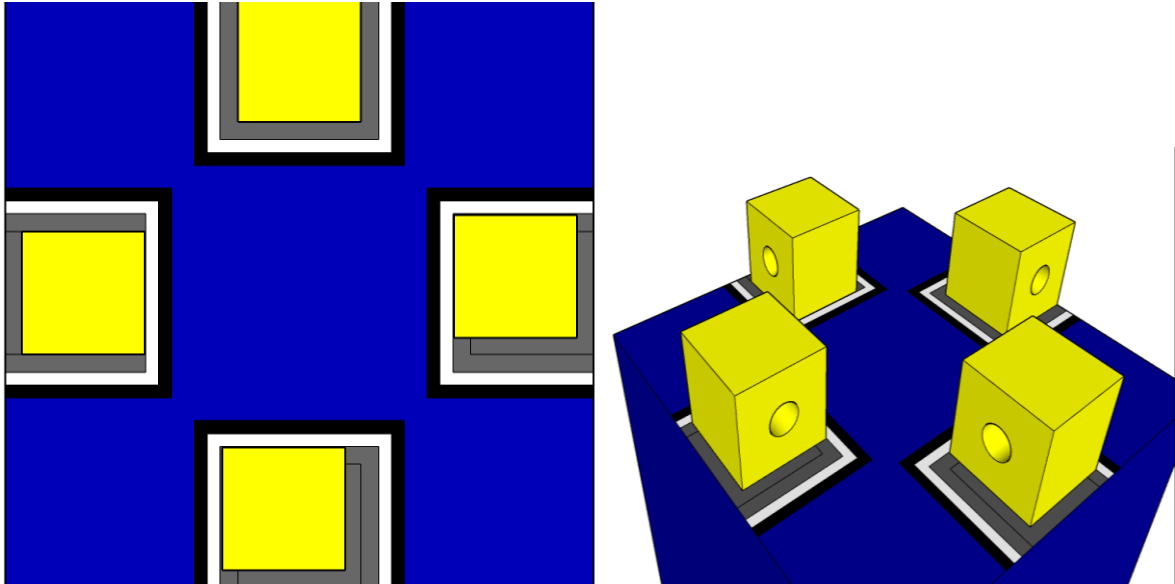

Figure 30. All cubes are positioned in the zone.

Partially in the zone:

The cube is considered positioned partially in the zone if any part of the cube's projection touches the area outside of the grey zone on top of the box but there is a part of the cube's projection that is still within the grey zone as described in the below figures.

1. If any part of the cube's projection touches the white zone outside of the grey square on top of the box but there is a part of the cube's projection that is still within the grey square – the cube is considered as first degree partially in the placing zone.
2. If any part of the cube's projection touches the black zone outside of the grey square on top of the box but there is a part of the cube's projection that is still within the grey square – the cube is considered as second degree partially in the placing zone.
3. If any part of the cube's projection is outside the black zone on top of the box but there is a part of the cube's projection that is still within the grey square – the cube is considered as third degree partially in the placing zone.

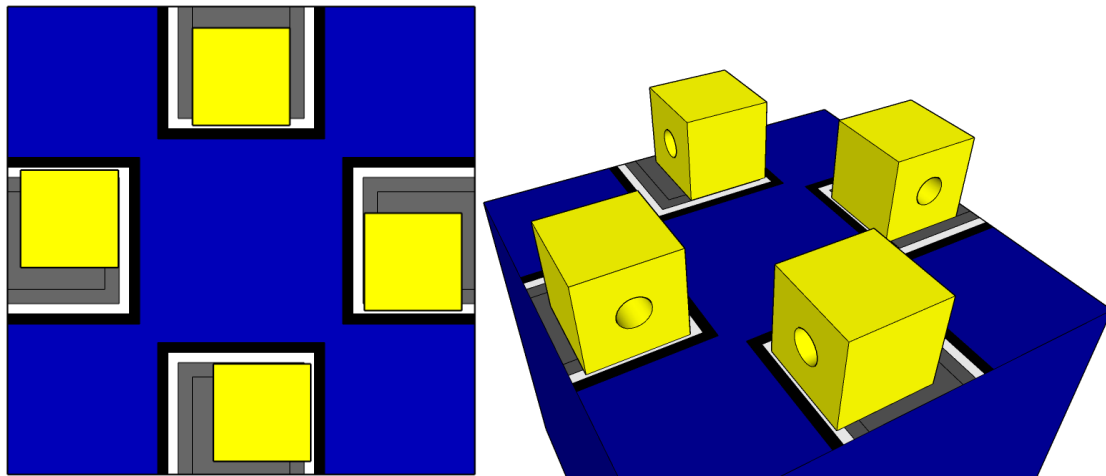

Figure 31.1 Four cubes are considered as first degree partially in the placing zones.

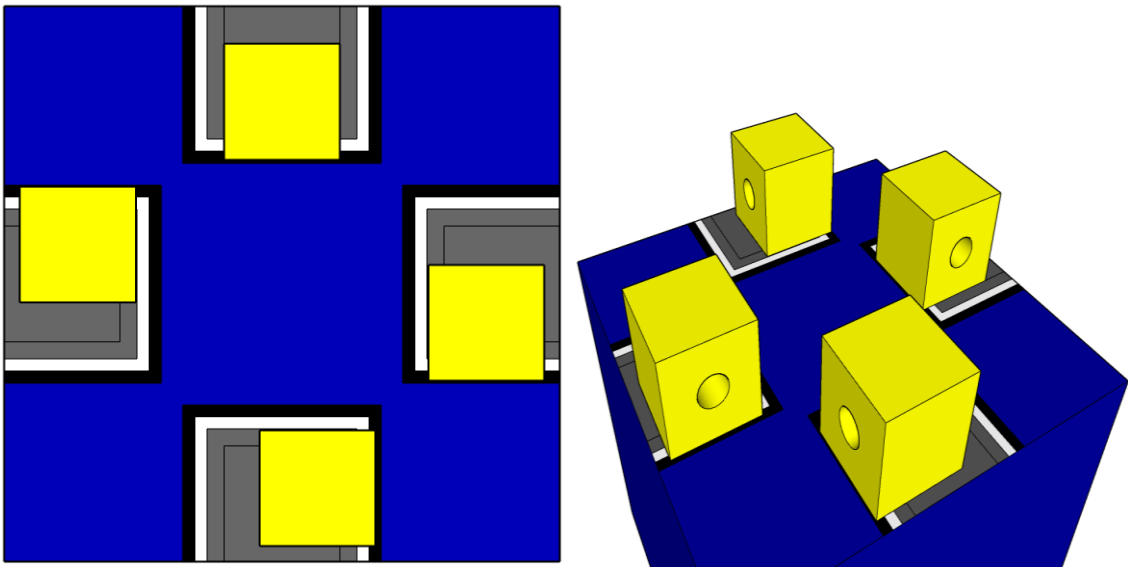

Figure 31.2 Four cubes are considered as second degree partially in the placing zones.

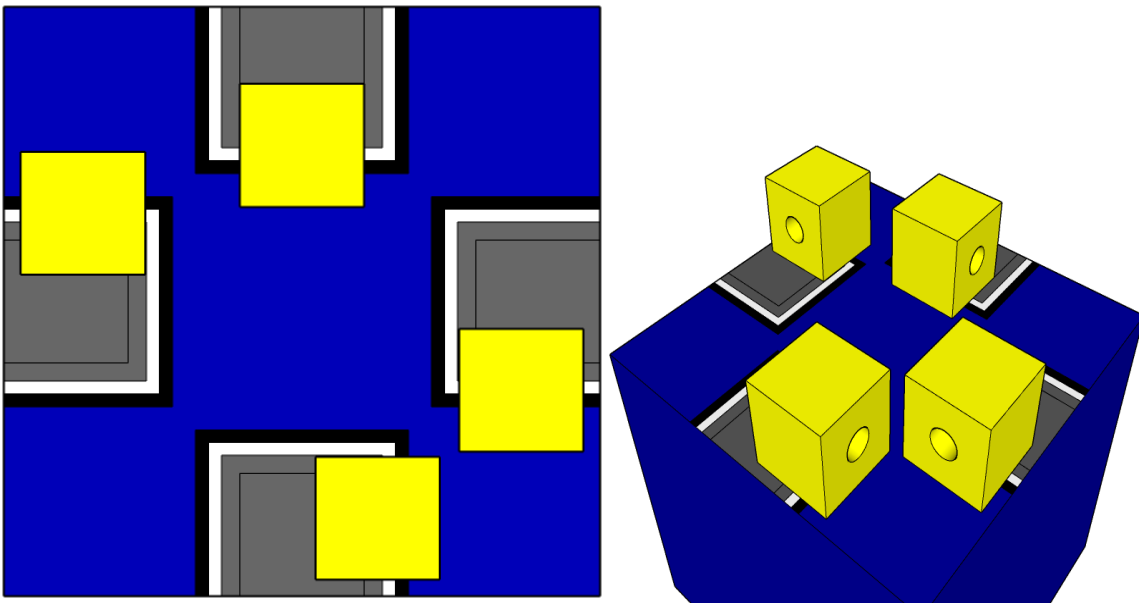

Figure 31.3 Four cubes are considered as third degree partially in the placing zones.

Out of the zone:

The cube is considered positioned out of the zone if the cube's projection is completely outside of **the placing zone** on top of the box as described in the below figure.

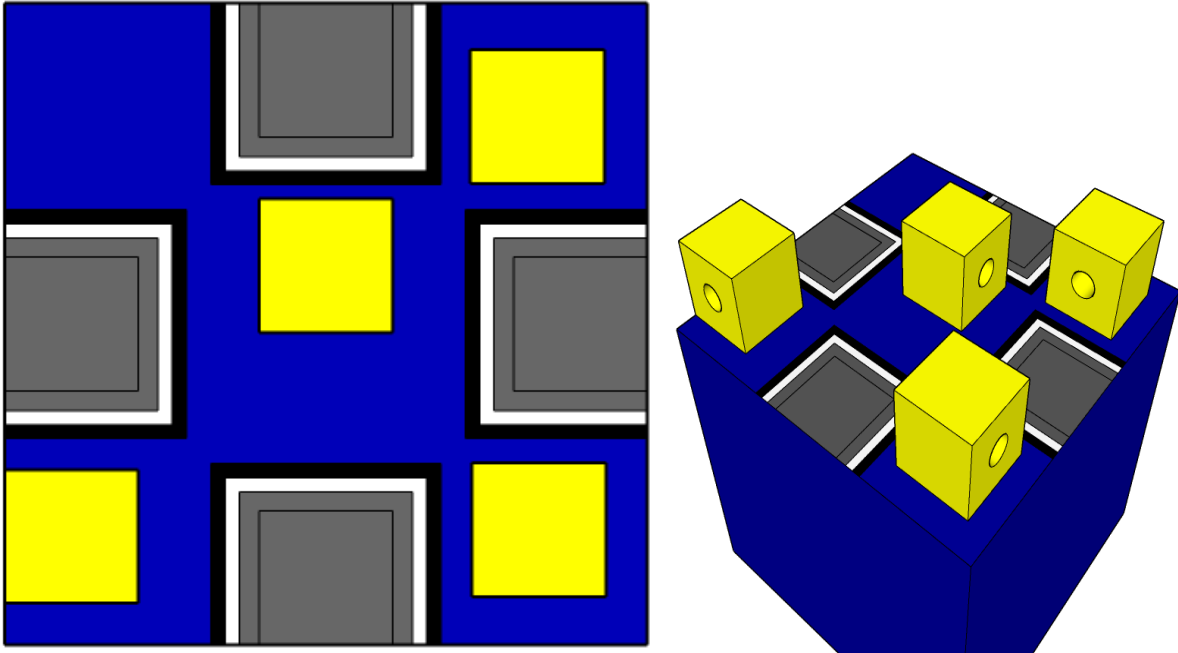

Figure 32. Four cubes are positioned out of the zone.

Cube's orientation:

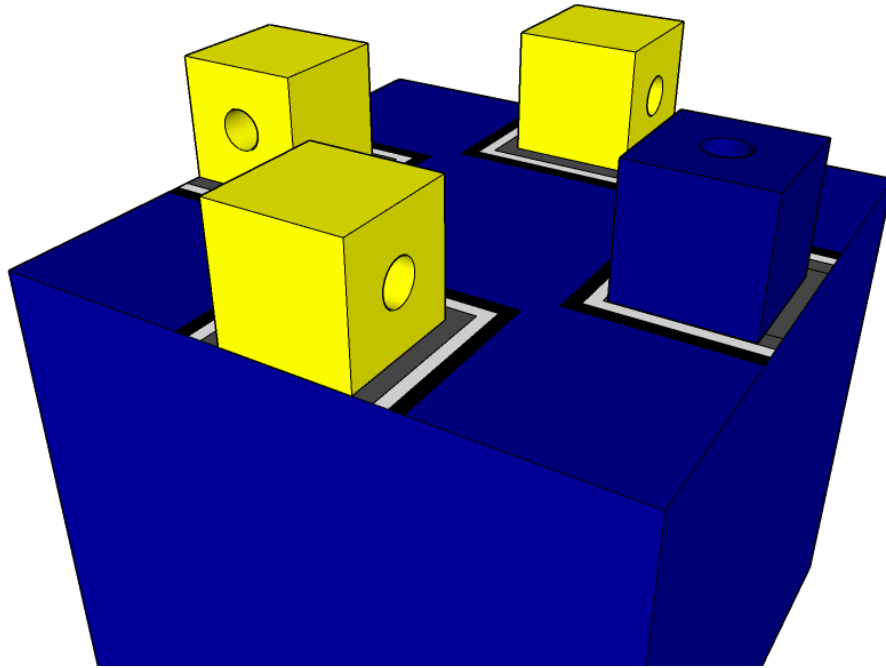

Figure 33. The cube which will be placed in that orientation, will get extra points.

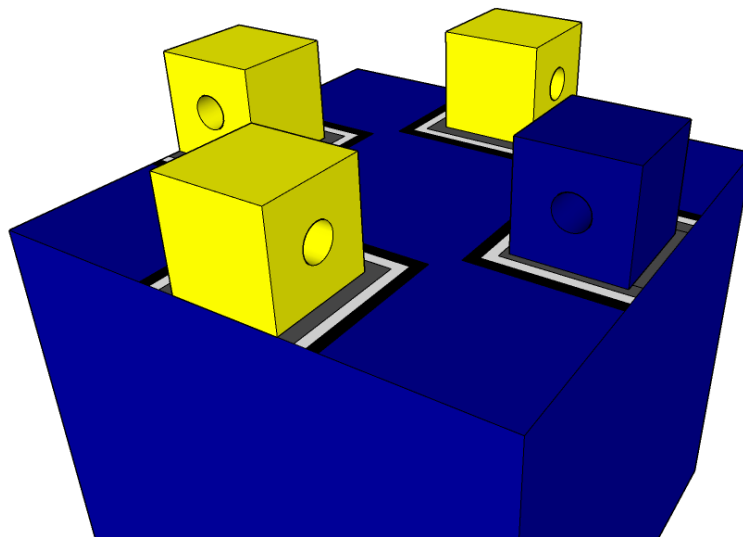

Figure 34. The cube which will be placed in that orientation, will not get the extra points.

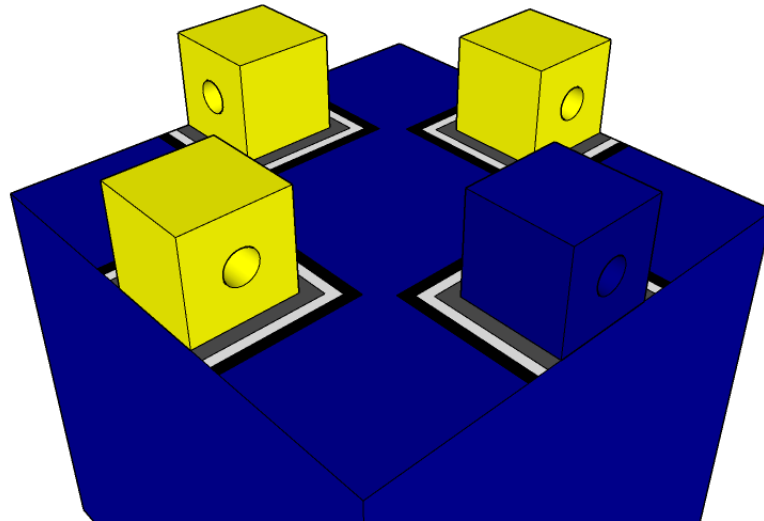

Figure 35. The cube which will be placed in that orientation, will not get the extra points.

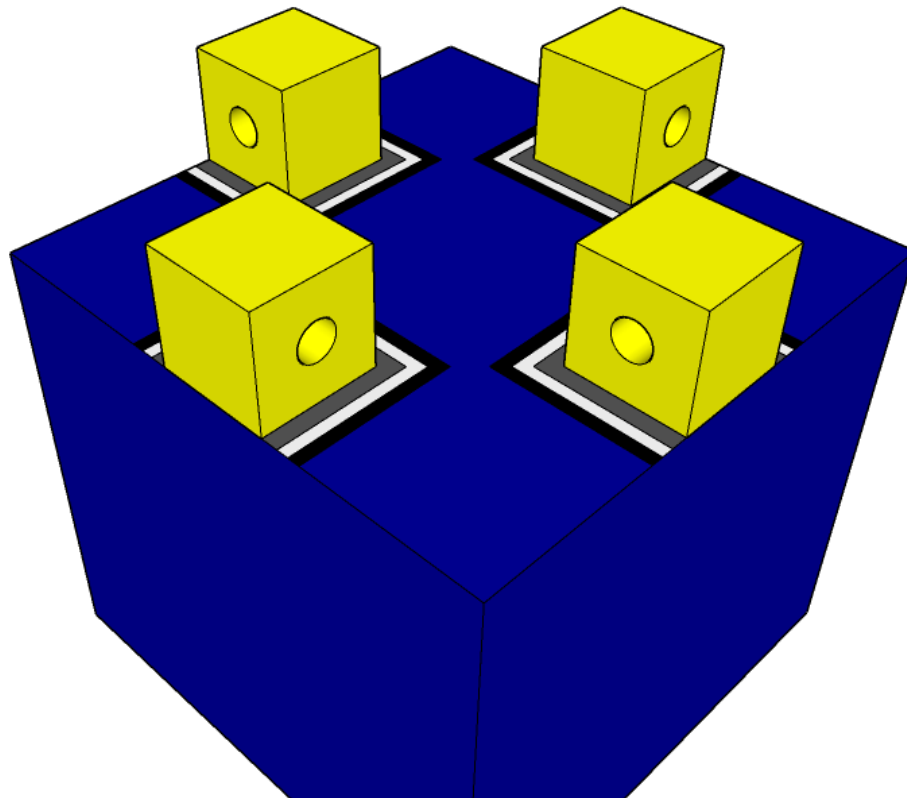

Figure 36. Initial orientation and position for the cubes on top of one of the boxes.