



World Robot Olympiad 2022

機器人任務-高中職組



照護機器人

版本：2022.01.15



第一部分 - 機器人任務規則	2
1. 簡介	2
2. 競賽場地	3
3. 競賽道具, 擺放位置, 隨機方式	4
4. 機器人任務	8
4.1. 送洗衣物	8
4.2. 標記方塊的資訊	8
4.3. 帶水到房間中	8
4.4. 玩遊戲	9
4.5. 機器人停車	9
4.6. 獎勵分數	9
5. 得分	10
6. 本地, 區域, 和 國際賽事	15
第二部分 - 組裝競賽道具	16

第一部分 - 機器人任務規則

1. 簡介

機器人可以豐富人們的日常生活並提供協助。例如引導我們參觀博物館，或是幫助我們完成乏味或吃力的任務。

在高中職組的任務中，機器人擔任醫院中護理與運輸的角色。將待洗衣物送到醫院中的洗衣區，把水送到不同的房間，並與病人一起玩樂。同時，在穿過醫院走廊時必須注意護理師和其他訪客。

2. 競賽場地

競賽場地的各區域顯示如下圖。



有些區域標有數字以利分辨。參考上圖在每個房間中有五個區域標有數字：

- 1：待洗衣物的位置
- 2：遊戲球的位置
- 3：遊戲網的位置
- 4：桌子的位置
- 5：標記方塊的位置

若競賽桌台大於底圖，**競賽底圖貼齊左下藍色房間（紅圈處）兩側牆邊。**

更多關於桌台與底圖資訊，請參考 WRO 通則中的規則 6。

底圖圖檔連結：www.wro-association.org。

3. 競賽道具，擺放位置，隨機方式

待洗衣物 與 洗衣籃

有三個待洗衣物塊（一個黑色、一個紅色、一個黃色）和三個洗衣籃（一個黑色、一個紅色、一個黃色）。這些物件會依下列規則擺放：

- 三個待洗衣物塊每回合會**隨機擺放**於四個房間內標示「1」的區域中。
- 三個洗衣籃每回合會**隨機擺放**於洗衣區的灰色方形上。



標記方塊

場地上有四個標記方塊（兩個白色、兩個綠色），每個回合**隨機擺放**於每個房間前方標記「5」的區域中。標記方塊用來辨別該房間需完成那些任務（參見任務描述）。

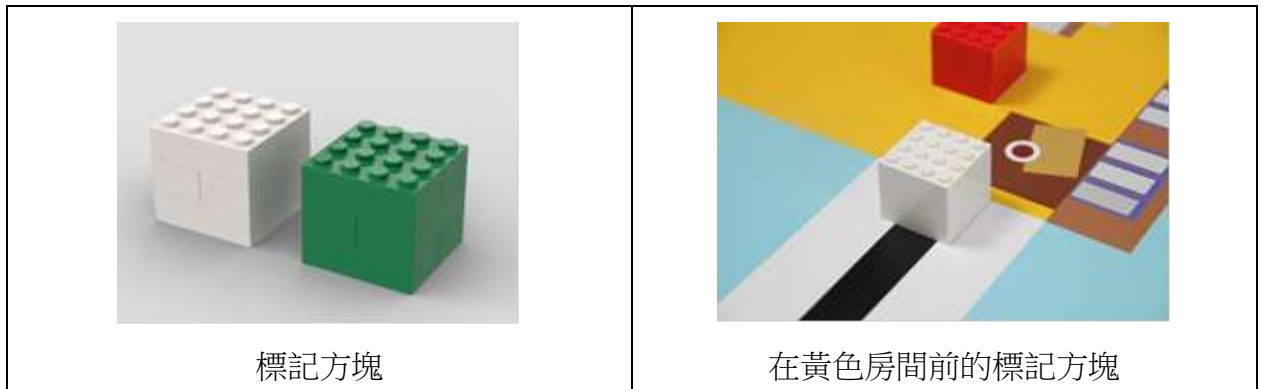





遊戲球 與 遊戲網

玩遊戲需要球與網子兩個物件。遊戲網有紅、黃、藍、綠色共四個並放置於對應顏色的房間標記「3」的區域中。遊戲球有兩顆紅色球與兩顆藍色球，紅球在黃色與綠色的房間中、藍球在紅色與藍色的房間中，放置於每個房間標記「2」的區域中，球放置在 2x2 樂高平板上。

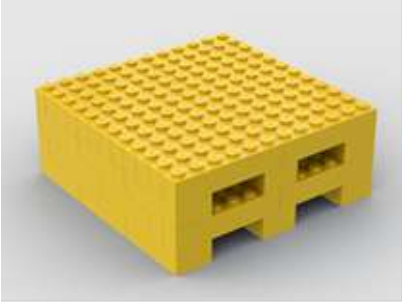

桌子 與 水瓶

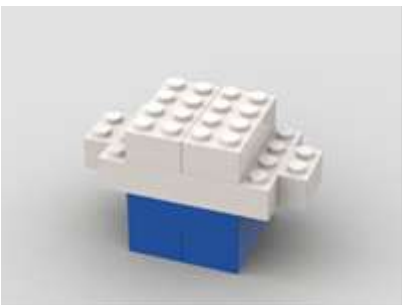
場地上有四張桌子（一張紅色、一張藍色、一張綠色、一張黃色），放置於對應顏色的房間標記「4」的區域中。此外場地上還有三個水瓶，水瓶放置在設備區域的預定位置。

 <p>桌子</p>	 <p>綠色房間中的綠色桌子</p>
 <p>水瓶</p>	 <p>設備區的水瓶物件，每個水瓶物件都按照底圖上的形狀方向擺放。</p>

人員

我們有六位人員在場地上（有黃色、綠色、紅色、藍色、白色和黑色）。這六位人員每回合中隨機擺放在八個紅色方形區域上。

 <p>人員</p>	 <p>場地上的黃色人員，每個人員物件都按照底圖上的形狀方向擺放。</p>
---	---

隨機化擺放

以下比賽物件每回合隨機放置於場地上：

- 標有「1」的區域的待洗衣物塊。
- 洗衣區三個方格上的洗衣籃。
- 標有「5」的區域上的標記方塊。
- 8 個紅色方形上的人員物件。

其他物件（水瓶、桌子、遊戲網和球）每回合也被放置在比賽場地上，但位置不是隨機的。

4. 機器人任務

為了有更詳細的說明，機器人任務將分成幾個章節介紹
隊伍可自行決定執行任務的順序

4.1. 送洗衣物

照護機器人的一項任務是幫助人類運輸材料，在醫院中，機器人將能幫忙把每間房間中的衣物運送到中央洗衣區。這也是場上的任務，機器人應該從房間中收集待洗衣物塊並送至洗衣區；如果將待洗衣物塊放置在對應顏色的洗衣籃內（例如：將紅色待洗衣物塊放置紅色的洗衣籃），則可完全獲得分數。

洗衣籃不須停留在他們的初始位置（意思是機器人可以稍微移動它們以將待洗衣物置入），然而，重要的是洗衣籃仍須完全在洗衣區內。

4.2. 標記方塊的資訊

對於接下來的兩個任務，要參照在初始時每個房間前面的標記方塊（允許被移動掃描）。標記方塊的位置決定了以下情況：

- 房間前面是白色標記方塊：放一個水瓶在這個房間的桌子上。請注意，如果機器人將水瓶帶到錯誤的房間，則會被扣分。
- 房間前面是綠色標記方塊：機器人應該和這個房間的居民玩遊戲。只有當機器人在正確的房間玩遊戲時，才會獲得分數。

4.3. 帶水到房間中

在醫院裡，每個房間裡的每個病人都有足夠的水喝是很重要的。因此，照護機器人的一項任務是每天給不同的房間送水。但要注意，只須把水帶到那些需要水的房間。

機器人應從設備區域取出水瓶並將其帶到正確的房間（前面有白色標記方塊的房間）。如果水瓶在正確的房間裡，則獲得分數，如果水瓶正確地站在桌子上，則獲得最高分。每個房間最多一個水瓶，設備區有一個備用水瓶。

請注意，場地上有 3 個水瓶，機器人任務只需要 2 個水瓶。第三瓶只是備用品。

4.4. 玩遊戲

照護機器人的另一項任務是與住院的人一起遊玩，但當然沒有足夠的機器人每天和每個人一起玩遊戲，這就是為什麼機器人應該只在標有綠色標記的房間裡玩遊戲。

要在正確的房間（前面有綠色標記方塊的房間）內進行遊戲，機器人應將球舉至遊戲網內（球的顏色並不重要。），如果球只接觸遊戲網而不接觸比賽場地，則獲得滿分。

4.5. 機器人停車

機器人回到開始與結束區後自動停止且機器人正投影完全在結束區內(電線不受此限制)，則任務完成。

4.6. 獎勵分數

在穿越醫院時，機器人注意周遭的一切是很重要的。門、樓梯、轉角，當然還有我們人類。因此，機器人應注意避開競賽場地上的人員物件。

未移動或損壞場地上的人員將獲得獎勵分數。此外，未移動或損壞房間內的遊戲網和桌子將獲得獎勵分數。

5. 得分

得分的定義

“完全”是指競賽物件只與對應的區域接觸(不包含黑線)

任務	每個	總共
送洗衣物		
待洗衣物塊完全位於洗衣區域內（含洗衣籃上方），但不在洗衣籃內。	6	18
待洗衣物塊在相異顏色的洗衣籃內且洗衣籃仍完全在洗衣區域內。	10	30
待洗衣物塊在對應顏色的洗衣籃內且洗衣籃仍完全在洗衣區域內。	16	48
帶水到房間中(前方有白色標記方塊的房間，每間最多記一次)		
水瓶完全在正確的房間內，但不在桌上。	6	12
水瓶物件部分或完全在由標記方塊標明錯誤的房間內。	-6	-12
水瓶物件在正確的房間桌子上，但沒有直立，沒有損壞，且桌子仍在深灰色區域內。	10	20
水瓶物件在正確的房間桌子上，直立，沒有損壞，且桌子仍在深灰色區域內。	14	28
玩遊戲(前方有綠色標記塊的房間)		
球在遊戲網內(一個網子只計算一顆球)。	13	26
機器人停車		
機器人完全停止在「開始和結束區」（僅當有獲得獎勵分數以外的分數時才能獲得）。		13
獎勵分數（僅當有獲得獎勵分數以外的分數時才能獲得）		
每個沒有被移動或損毀的人員物件。	4	24
每個沒有被移動或損毀的遊戲網。	2	8
每個沒有被移動或損毀的桌子。	2	8
最高總得分		155

得分釋義

待洗衣物塊完全位於洗衣區域內，但不在洗衣籃內或上方→每個 6 分。

待洗衣物塊在相異顏色的洗衣籃內且洗衣籃仍完全在洗衣區域內→每個 10 分。

待洗衣物塊在對應顏色的洗衣籃內且洗衣籃仍完全在洗衣區域內→每個 16 分。



48 分 (3 x 16 分)，每個待洗衣物方塊都在正確的洗衣籃中。洗衣籃在洗衣區域中移動沒有關係。

0 分，方塊沒有完全在洗衣區域中。

6 分，方塊在洗衣區域中，但不在洗衣籃內（與洗衣籃在洗衣區內或外無關）。



10 分，方塊在洗衣區域內但在錯誤顏色的洗衣籃中。

6 分，方塊在洗衣區域中，但不在洗衣籃內。

16 分，方塊在對應顏色的洗衣籃中。



0 分，洗衣籃與方塊都不在洗衣區域中。

0 分，即使待洗衣物塊已經在洗衣籃內，洗衣籃在區域外仍無法拿到分數。

水瓶完全在正確的房間內，但不在桌上→每個 6 分。



6 分，水瓶在有白色方塊標記的房間內。

0 分，部分在房間內。

水瓶物件不再正確的房間內→每個扣 6 分。



扣 6 分，水瓶物件在錯誤的房間（有綠色方塊標記的房間）。

扣 6 分，水瓶物件部分在錯誤的房間。

扣 6 分，水瓶物件在錯誤房間的桌上。

水瓶物件在正確的房間桌子上，但沒有直立，沒有損壞，且桌子仍在深灰色區域內→每個 10 分。



10 分

0 分(損壞)

請參見下方正確桌子位置的圖片。這些情況也適用於此。

水瓶物件在正確的房間桌子上，直立，沒有損壞，且桌子仍在深灰色區域內→
每個 14 分。



14 分



14 分，桌子被移動了，
但仍在深灰色區域內。



0 分，桌子被移動到深
灰色區域外。

球在遊戲網內(一個網子只計算一顆球)：每個 13 分。



13 分

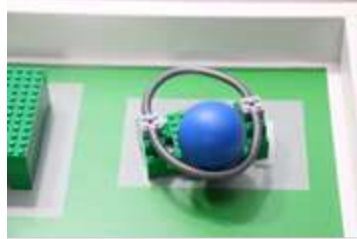

13 分，遊戲網被移動但仍在
灰色區域中。

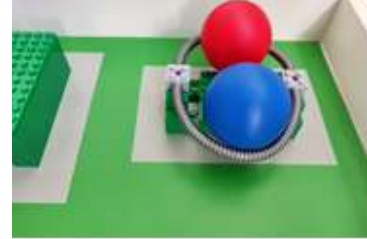

13 分，每個遊戲網僅計算一
顆球的分數。

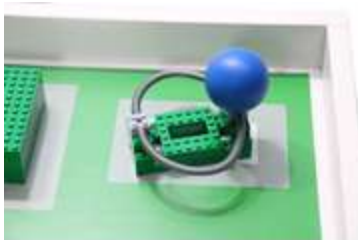

0 分，球不在遊戲網內。



0 分，遊戲網被移動到灰色區
域外。

機器人自動停止且完全在開始/結束區內(必須得到其他任務分數，且非獎勵分數) → 13 分。



機器人正投影完全在開始/結束區內

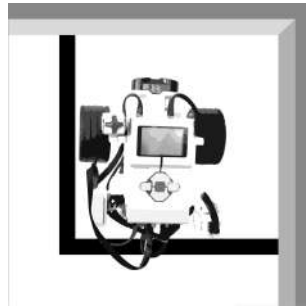

機器人的正投影完全在區域內，但電線在外是可以的。



0 分 如果機器人正投影沒有在開始/結束區內

每個沒有被移動或損毀的人員物件→每個 4 分。



4 分



4 分，被移動但仍在區域內。

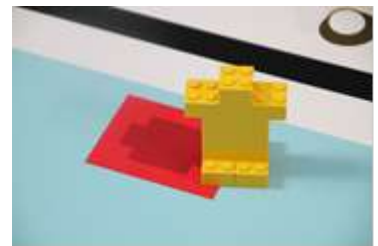

0 分，被移動到該區域外。



0 分，損壞。

其他獎勵分數物件遊戲網與桌子，與人員物件有相同的計分解釋。

6. 本地, 區域, 和 國際賽事

WRO 競賽在將近 90 個國家舉行，而我們也了解各個國家的隊伍都期望有更不一樣、不同層次的事物。此文件中所述的挑戰將會於 WRO 國際賽事中使用。那將會是擁有最佳解決方案隊伍參與賽事的最後階段。這也是為何競賽規則是具有挑戰的。

WRO 認為應該要讓所有參賽者都有好的參賽體驗。缺乏經驗的隊伍也能夠得到分數與追求成功。這將會建立他們精通技術與技巧的信心，對於他們在教育方面的未來選擇有很重要的影響。

所以 WRO 協會建議各國的主辦組織，若他們希望可將當地的賽事規則改簡單一些，讓更多的參與者進入比賽，擁有更正面的參賽體驗。組織擁有選擇權，讓賽事更融入當地的情勢和想法。以下是我們提供的簡化規則。

簡化的方法:

- 去除洗衣籃的隨機性。
- 去除標記方塊的隨機性。
- 去除人員物件的隨機性，或減少人員物件。
- 水瓶物件在起始時置於機器人上。

第二部分 - 組裝競賽道具

洗衣物塊（一個紅色、一個黃色、一個黑色）

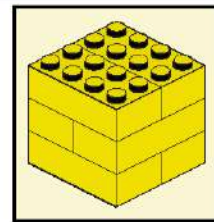
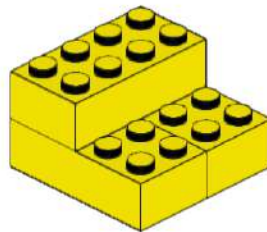
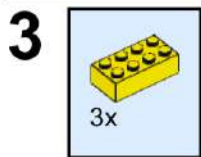
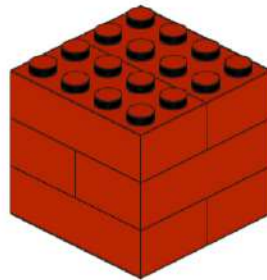
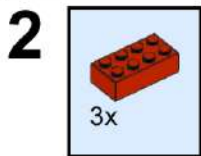
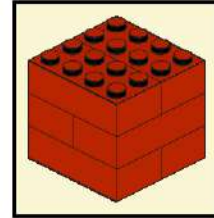
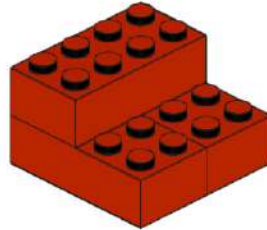
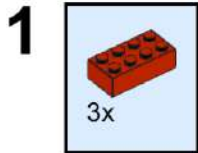

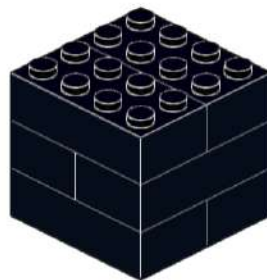
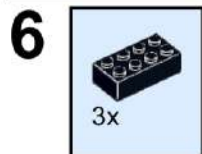
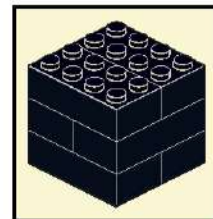
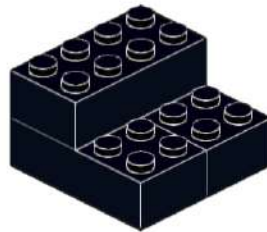
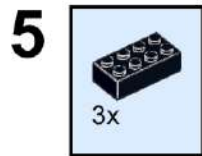
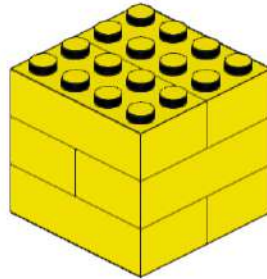
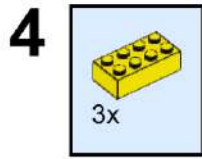

7

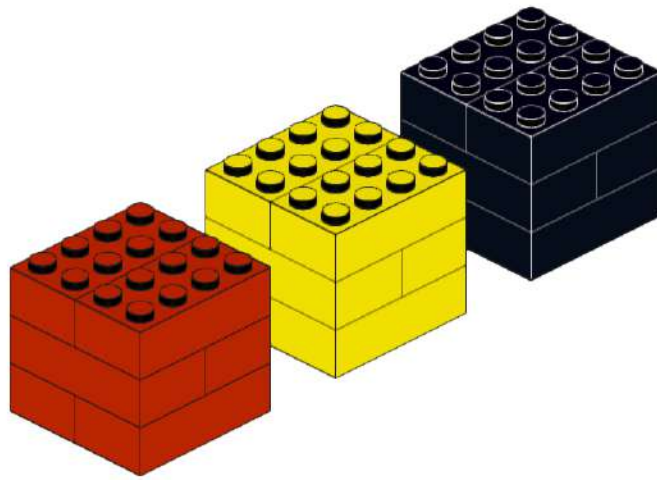

洗衣籃（一個黃色、一個紅色、一個黑色）

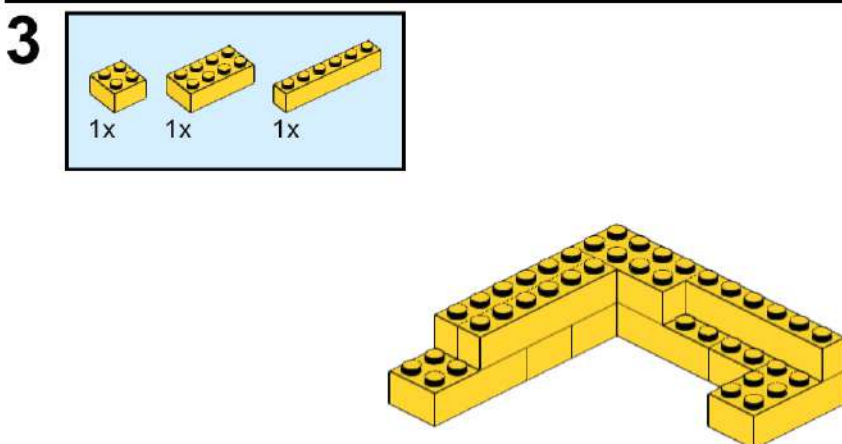
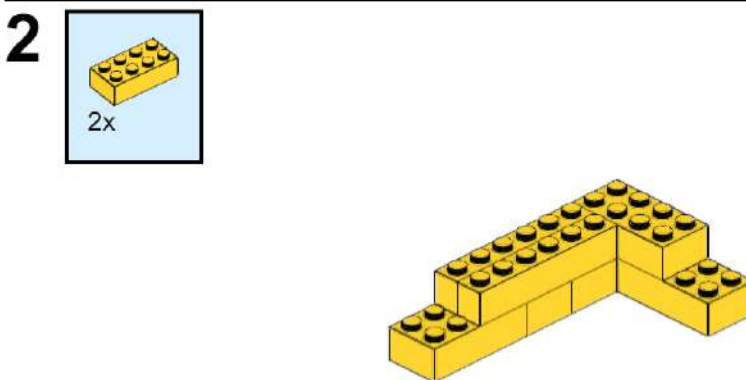
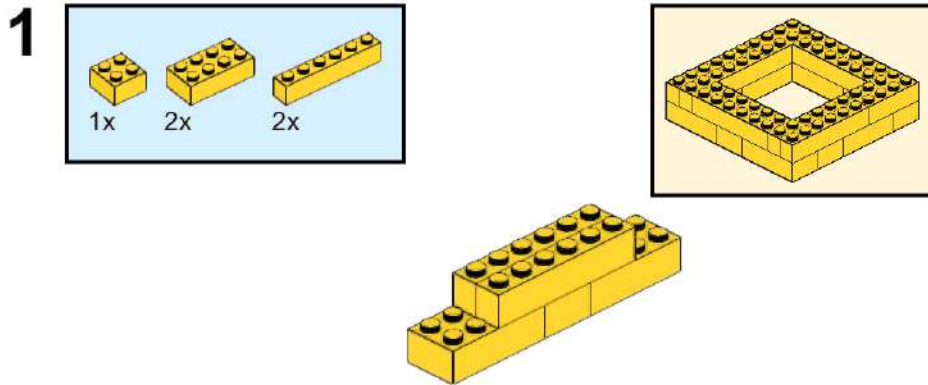

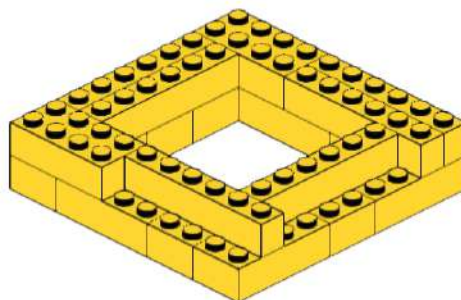
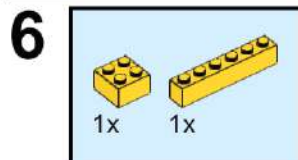
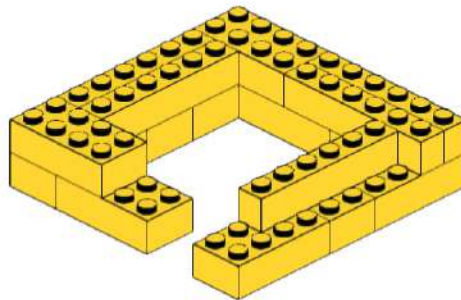
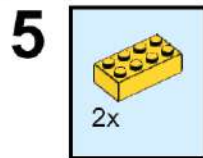
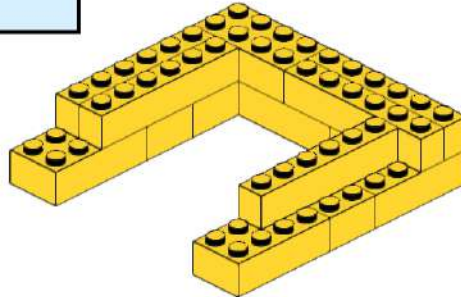
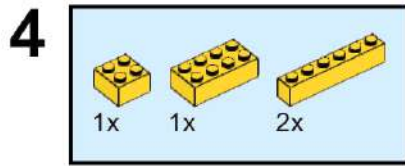

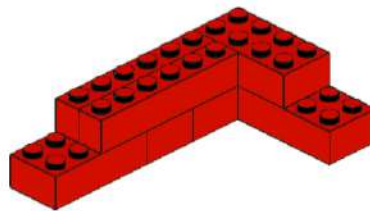
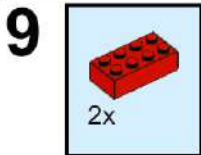
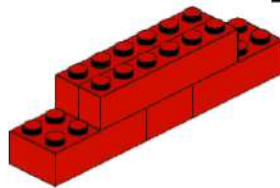
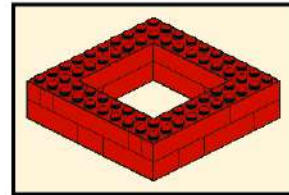
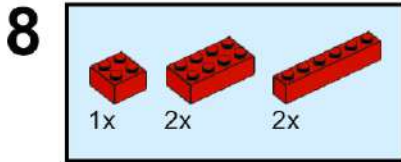
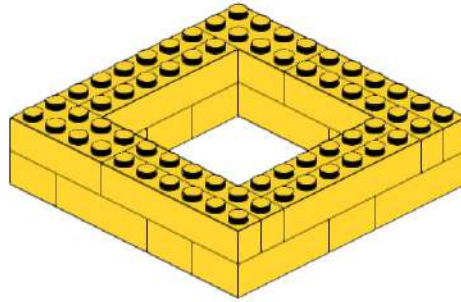
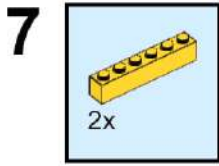

10

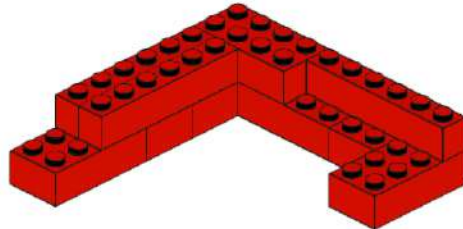
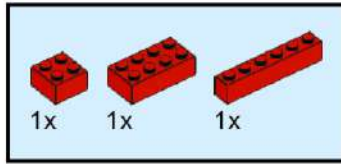

11

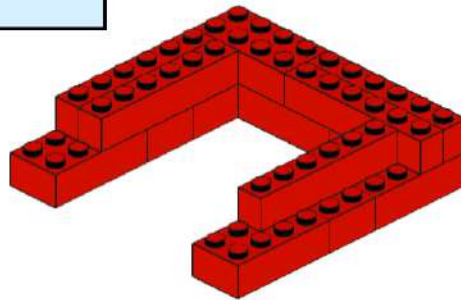
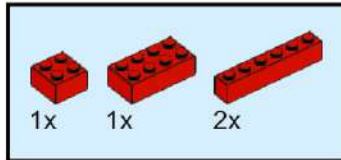

12

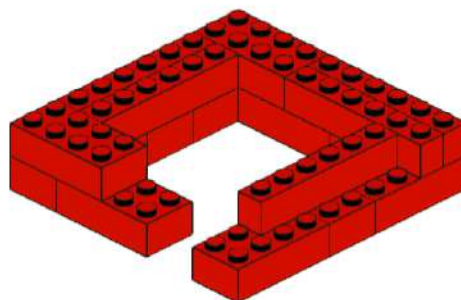
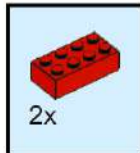

13

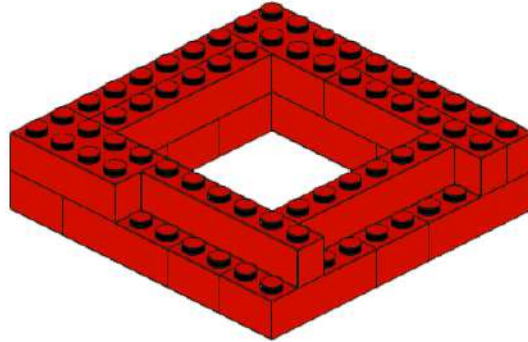
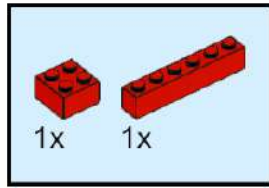

14

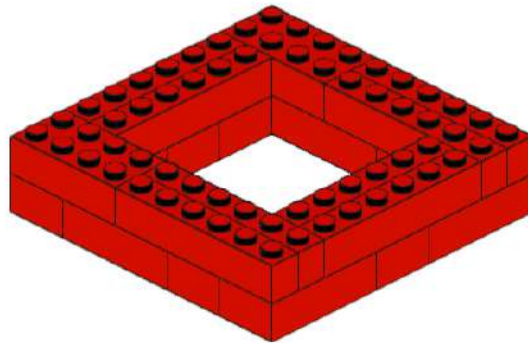
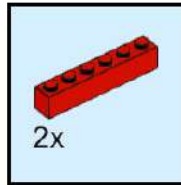

15

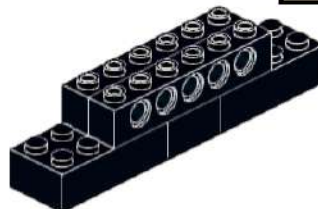
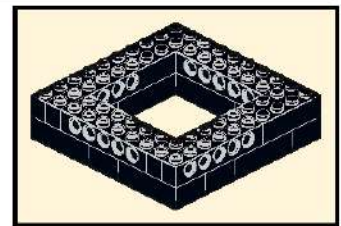
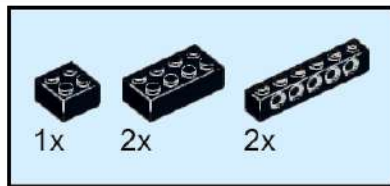

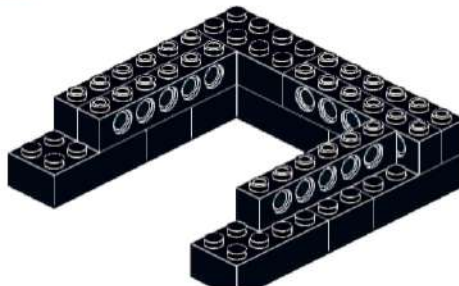
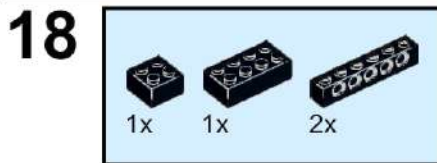
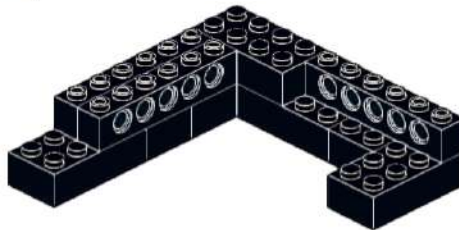
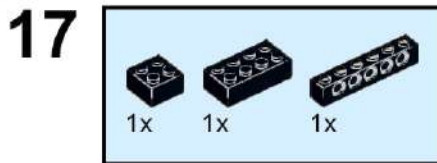
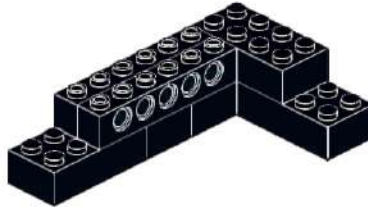
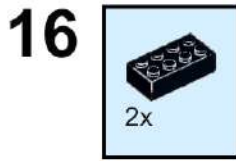

19

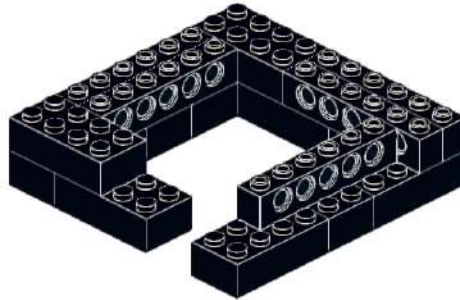

20

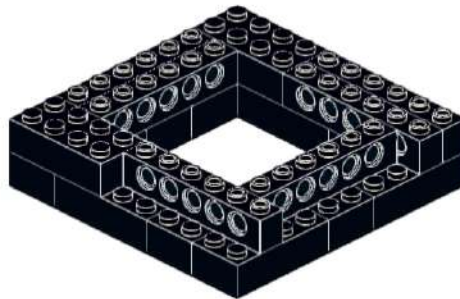
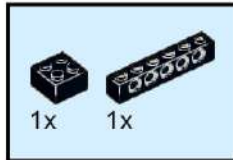

21

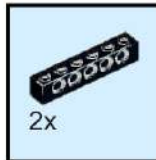

標記方塊（兩個白色、兩個綠色）

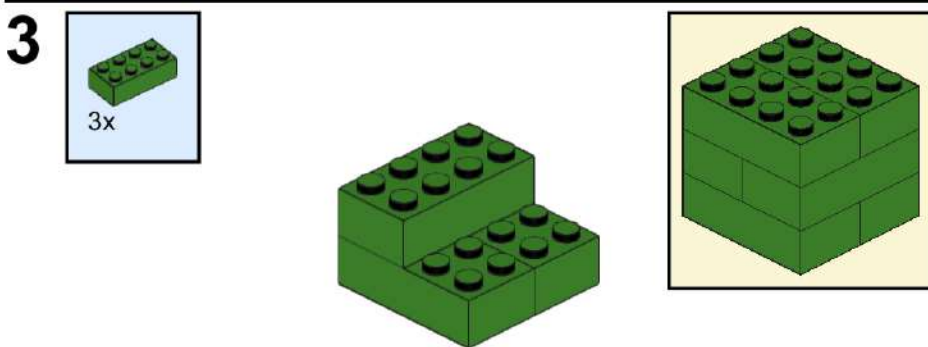
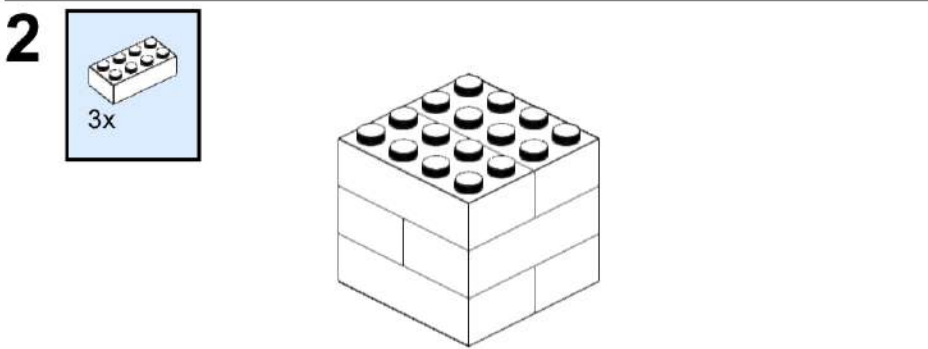
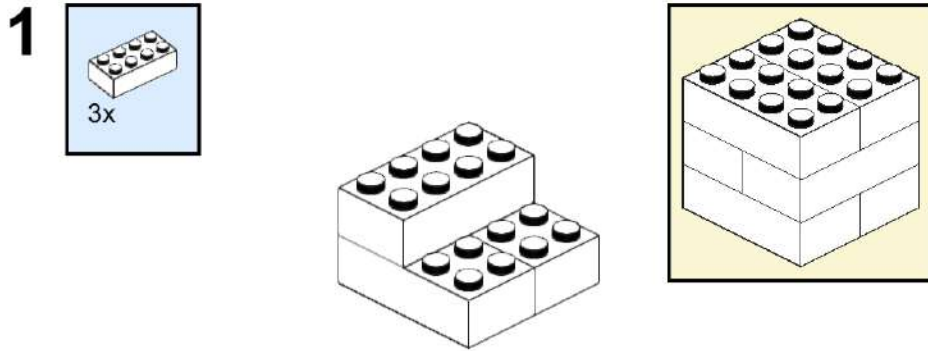

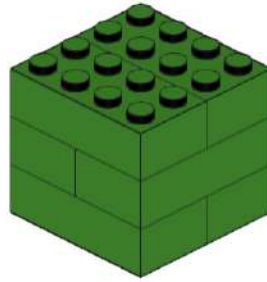
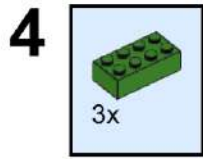

5

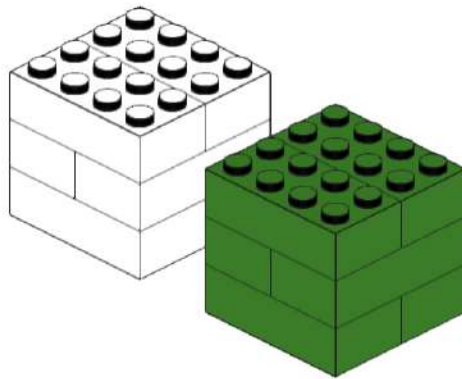

遊戲球(二個藍色、兩個紅色) 與 遊戲網 (一個藍色、一個黃色、一個綠色、一個紅色)

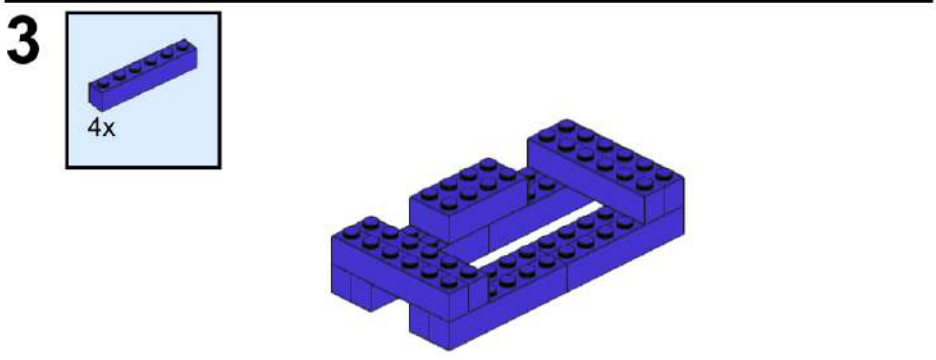
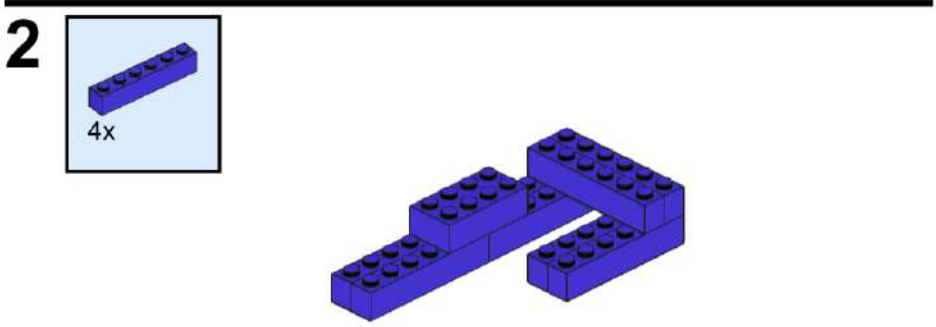
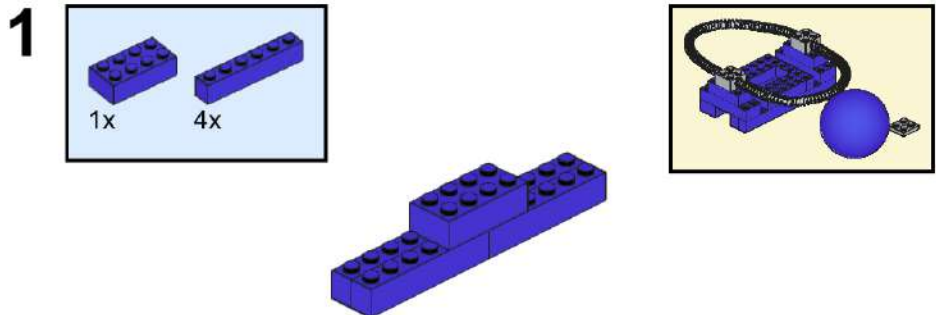

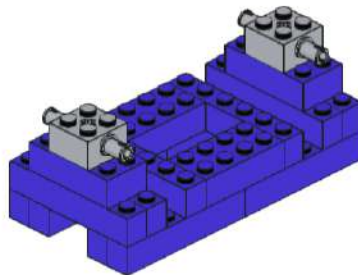
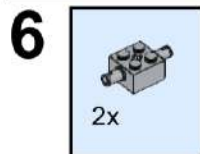
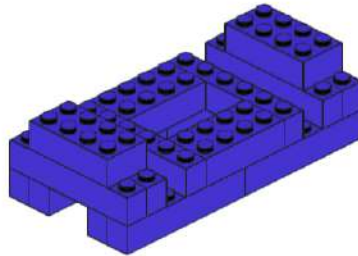
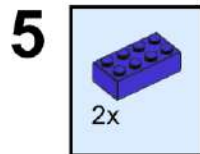
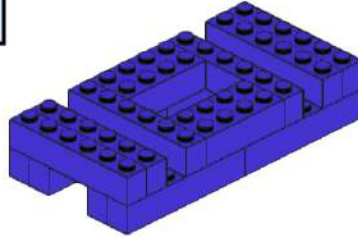
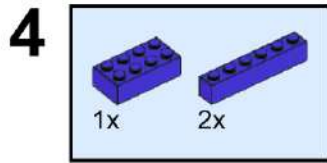

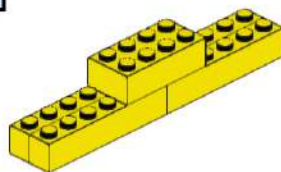
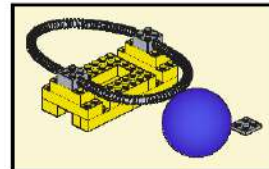
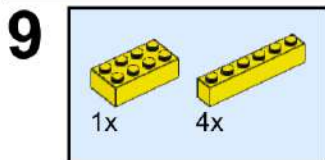
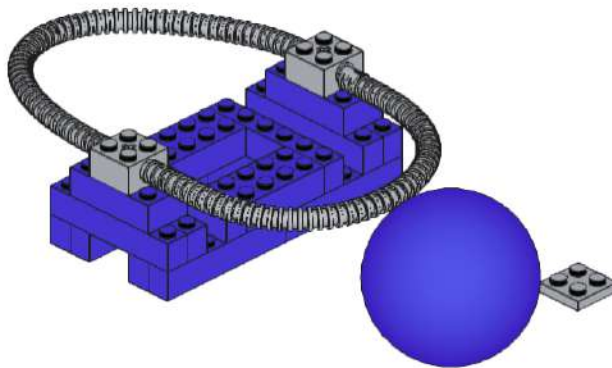
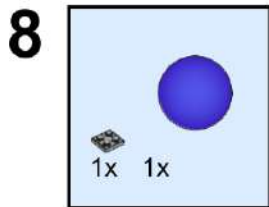
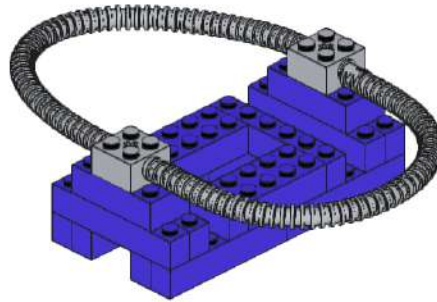
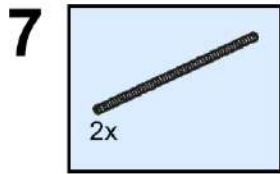

10

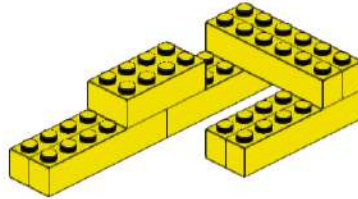
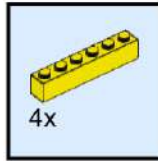

11

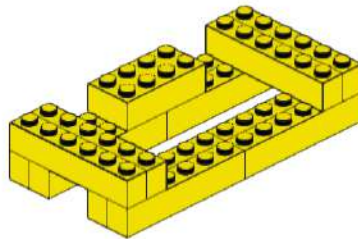
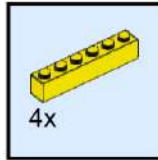

12

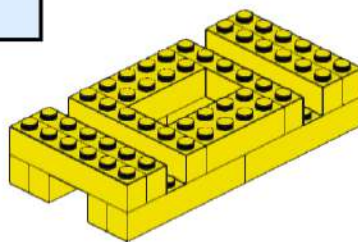
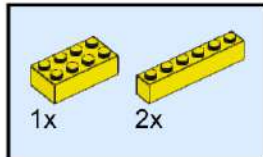

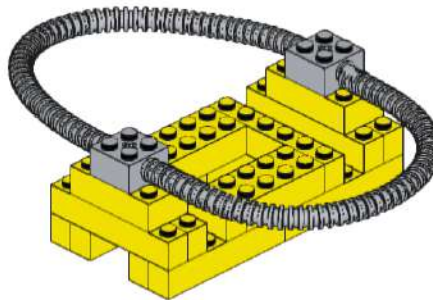
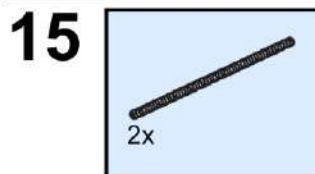
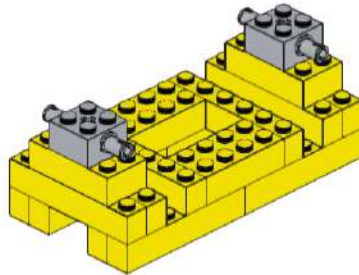
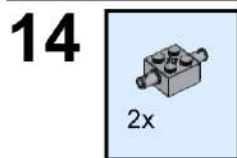
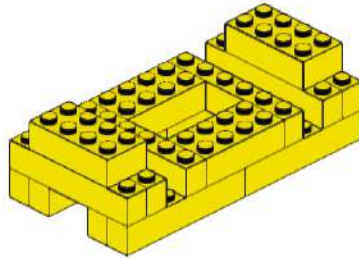
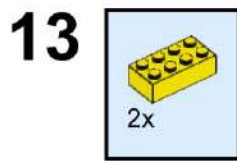

16

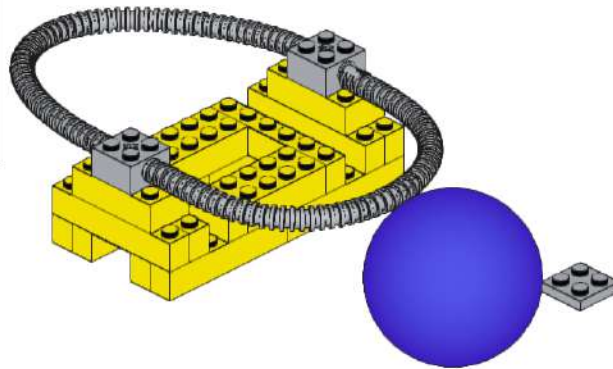
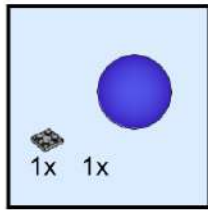

17

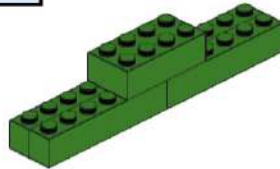
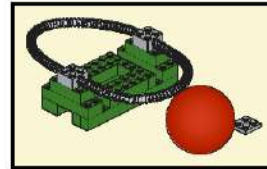
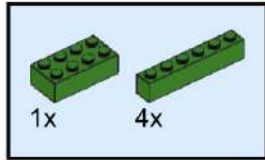

18

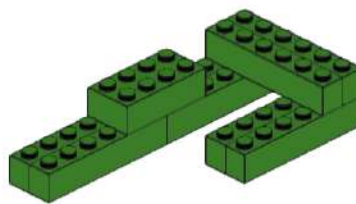
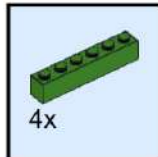

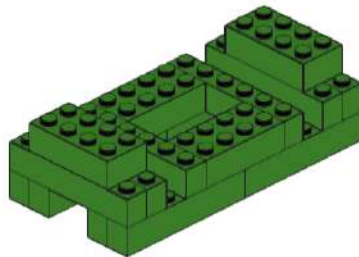
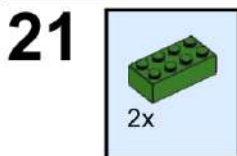
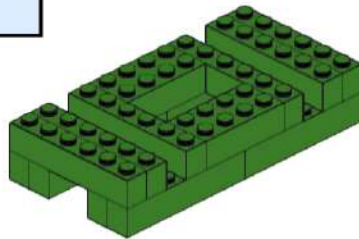
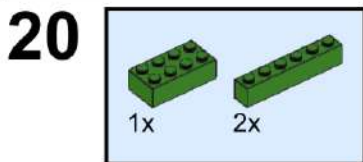
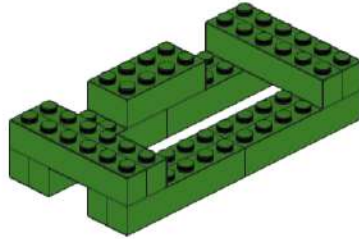
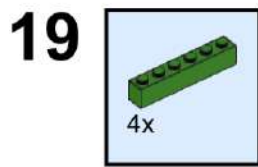

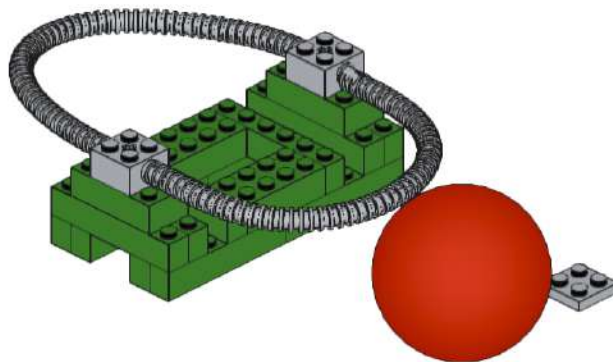
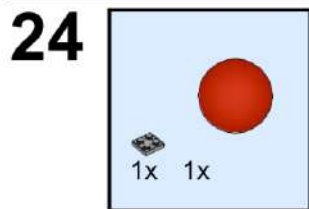
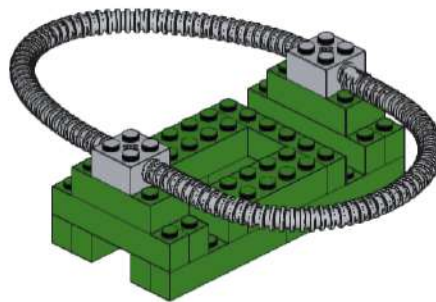
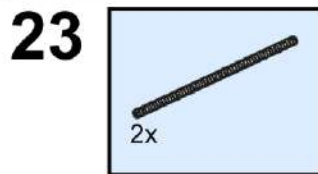
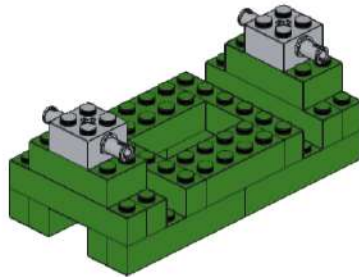
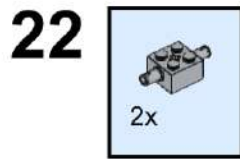

25

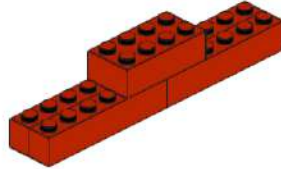
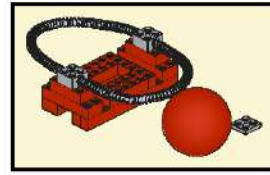
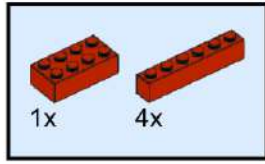

26

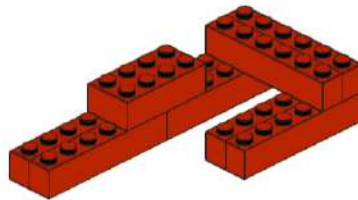
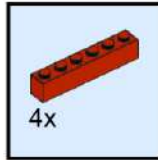

27

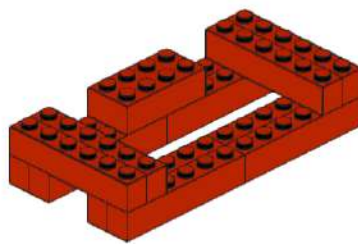
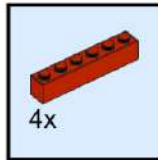

28

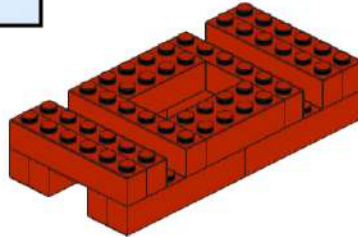
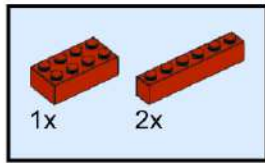

29

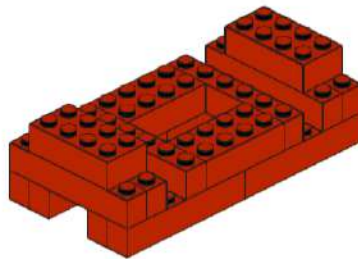
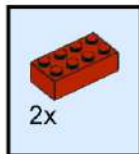

30

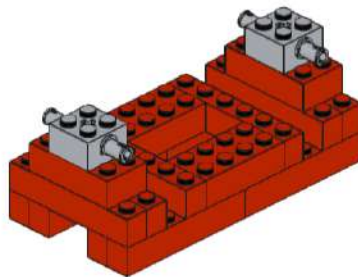
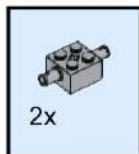

31

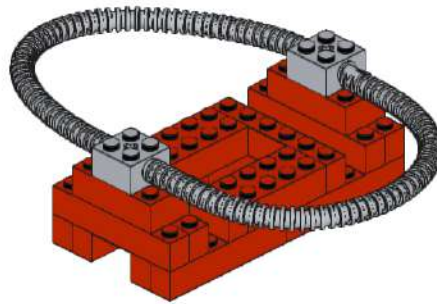
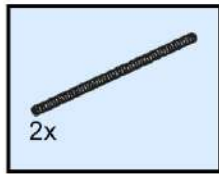

32

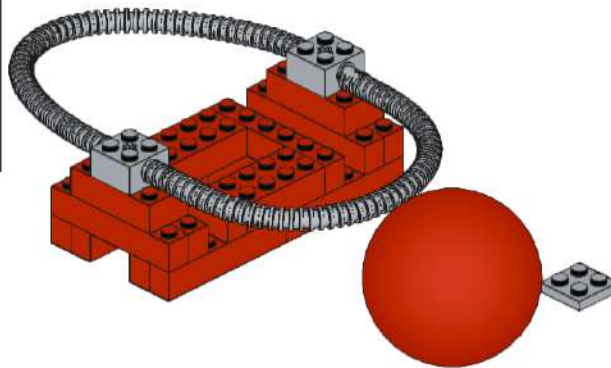
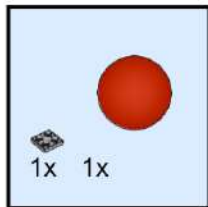

33

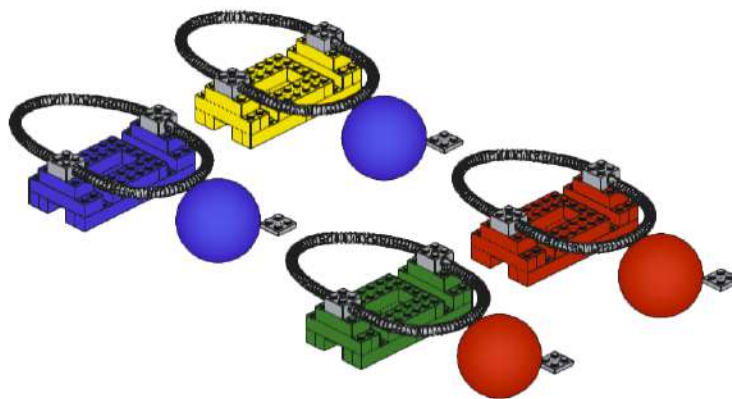

桌子（一個藍色、一個紅色、一個黃色、一個綠色）

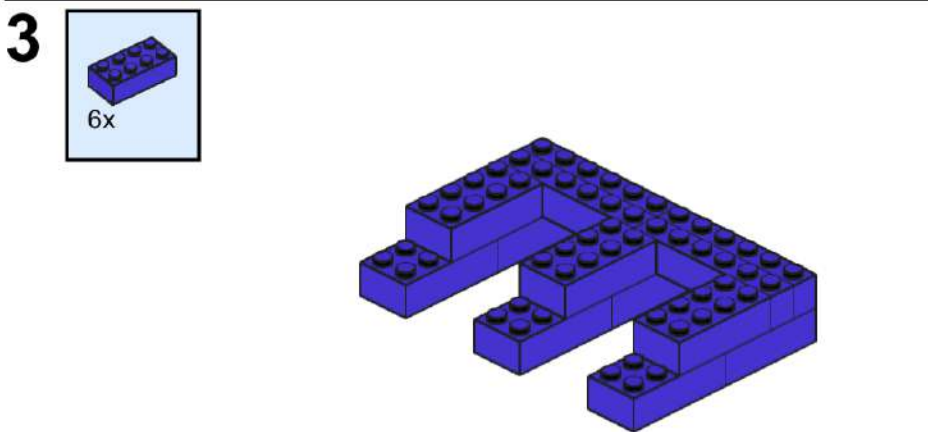
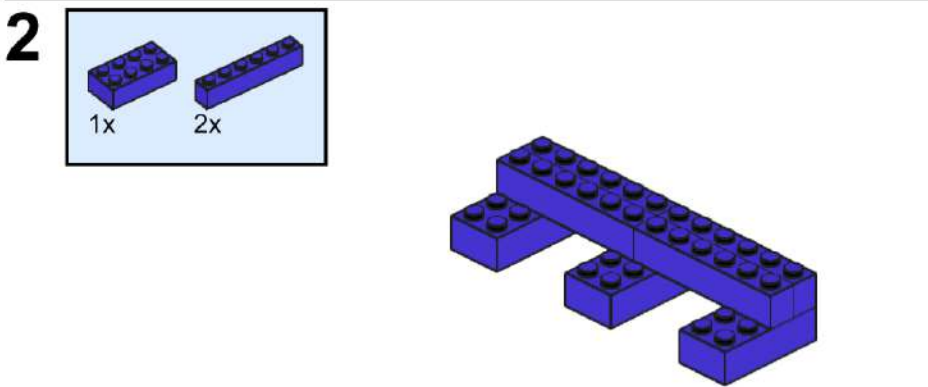
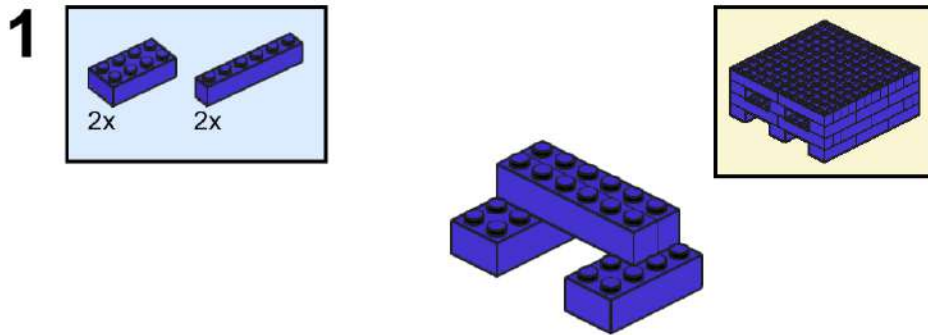

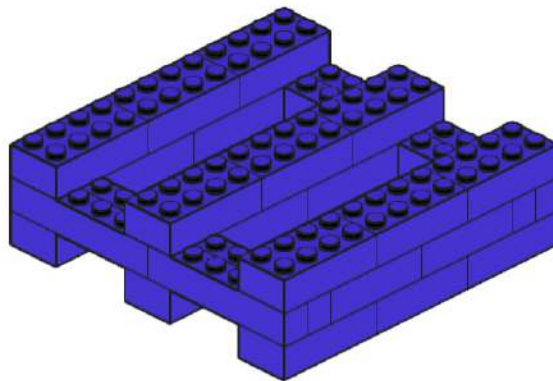
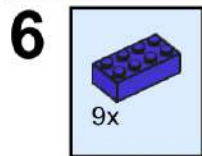
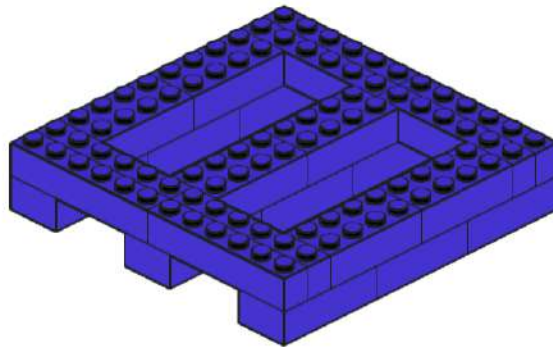
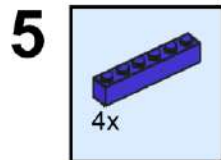
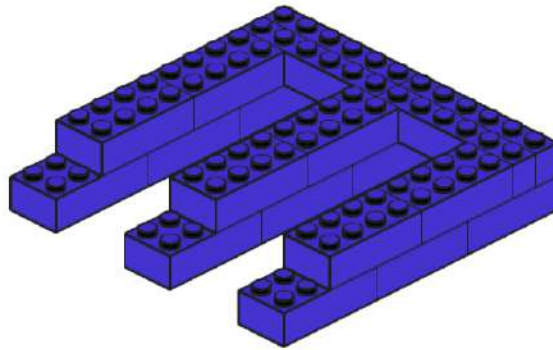
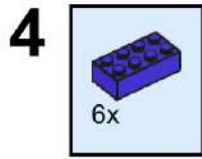

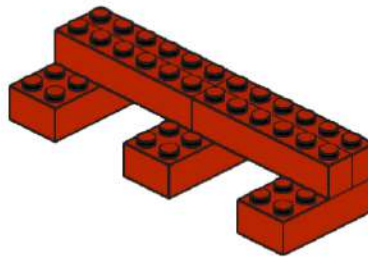
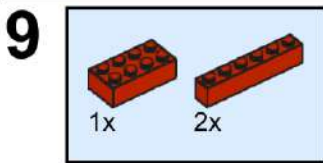
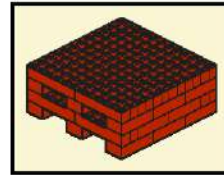
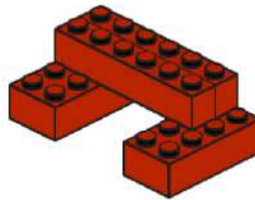
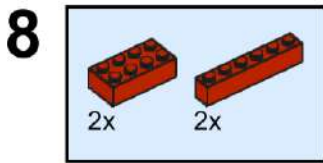
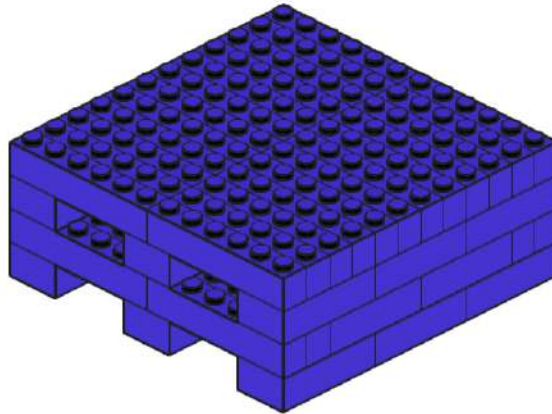
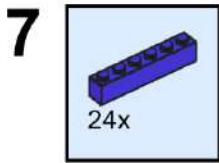

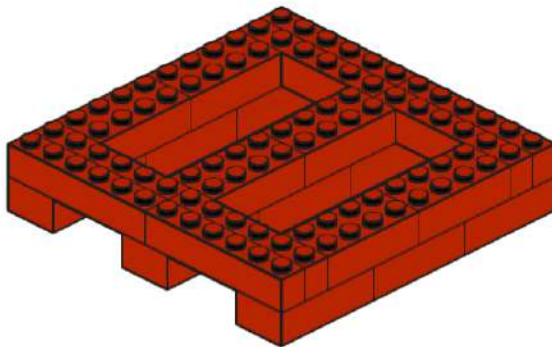
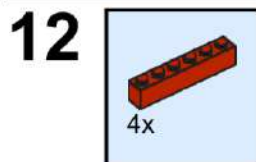
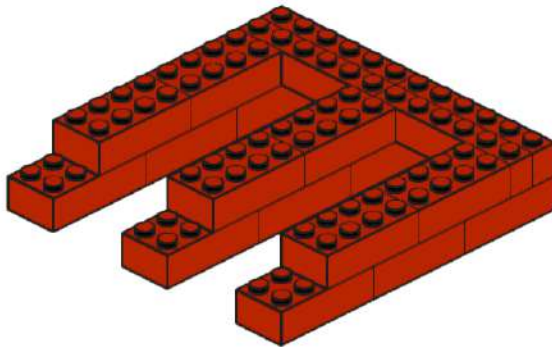
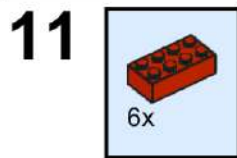
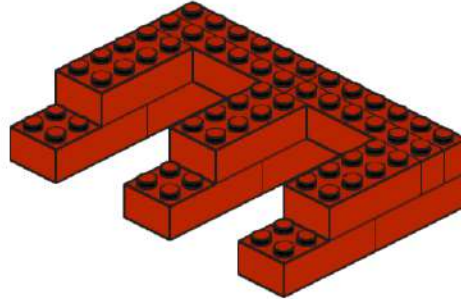
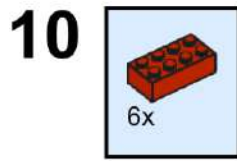

13

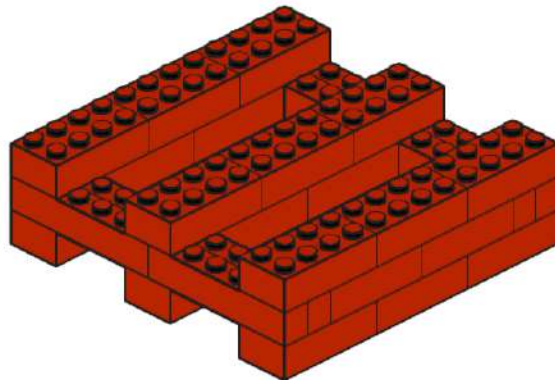
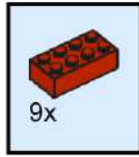

14

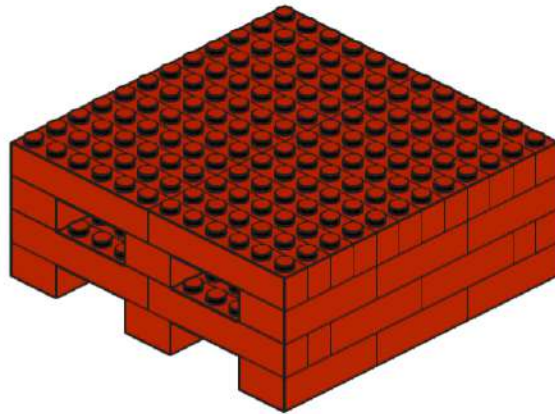
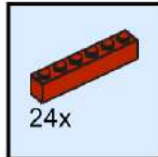

15

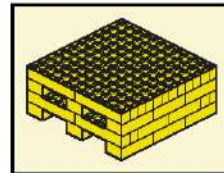
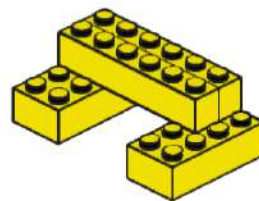
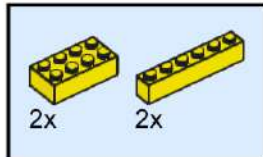

16

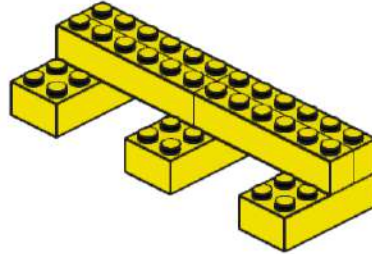
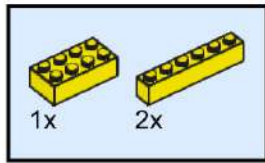

17

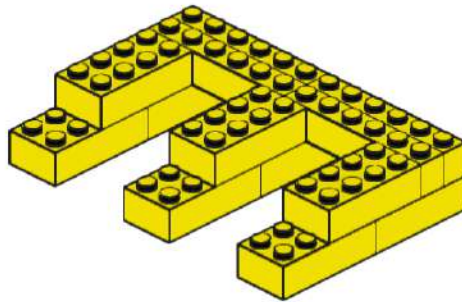
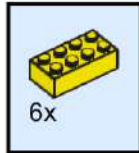

18

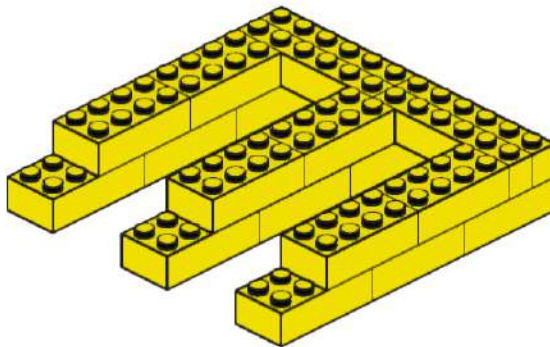
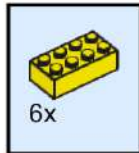

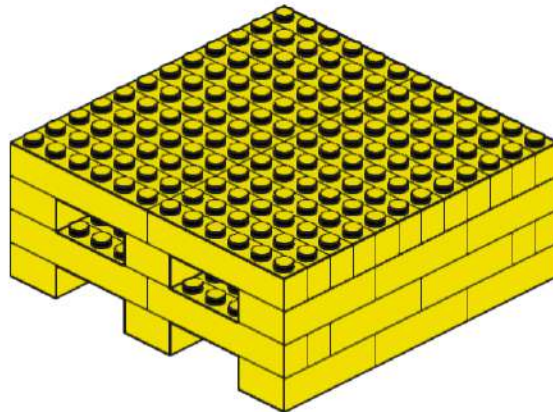
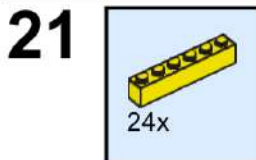
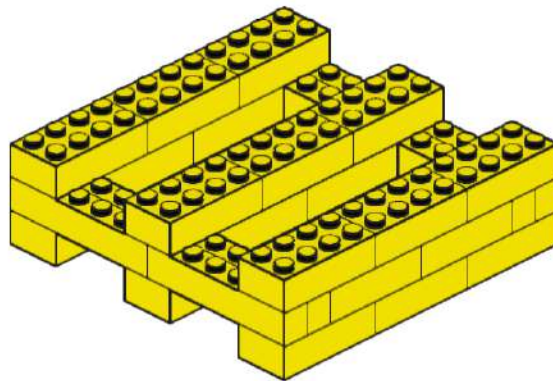
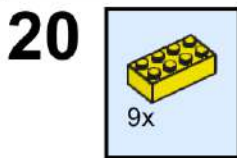
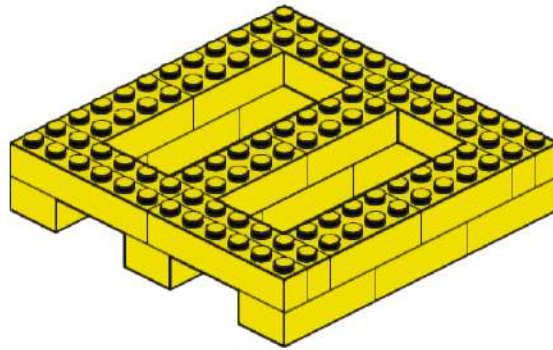
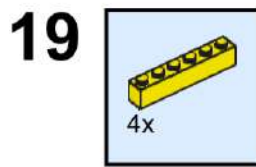

22

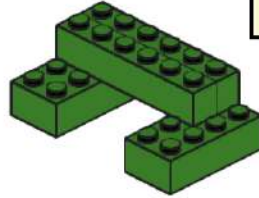
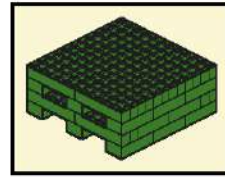
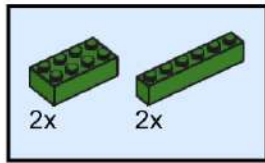

23

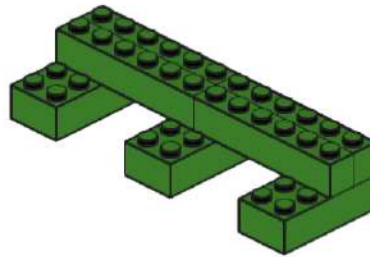
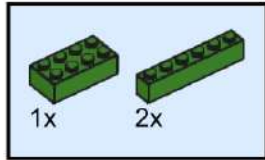

24

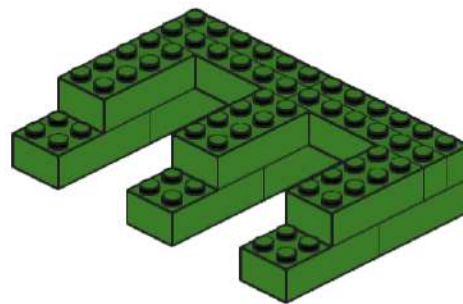
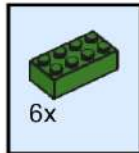

25

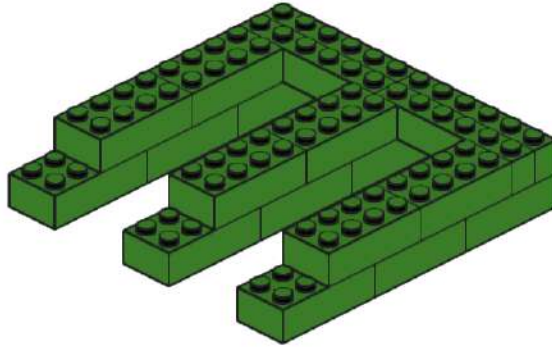
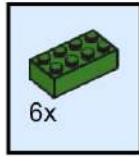

26

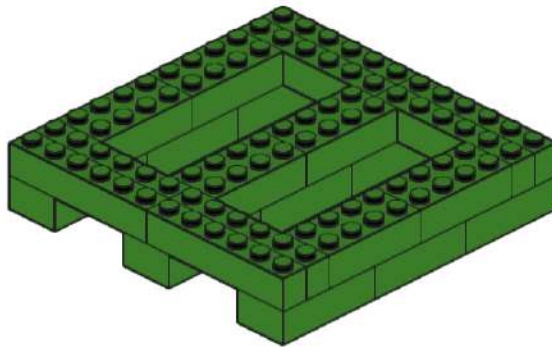
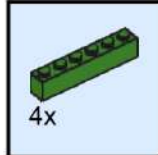

27

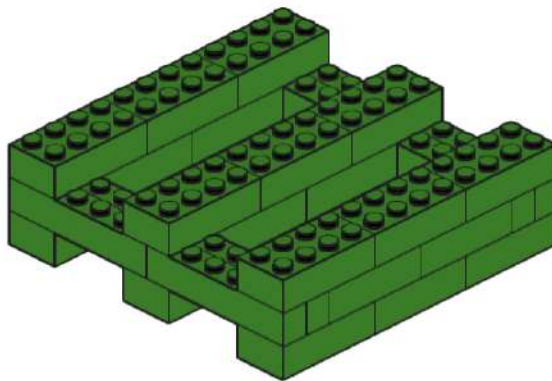
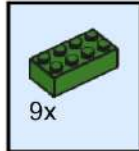

28

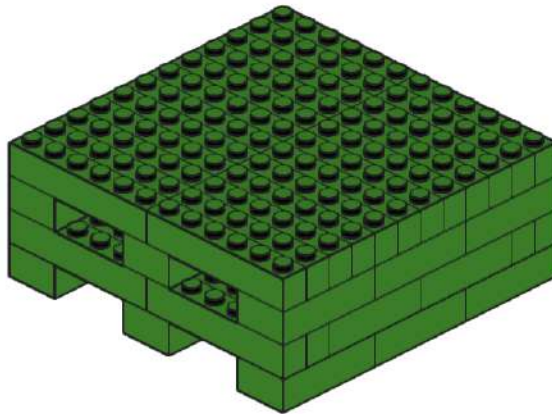
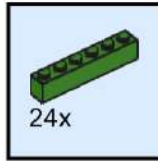

29

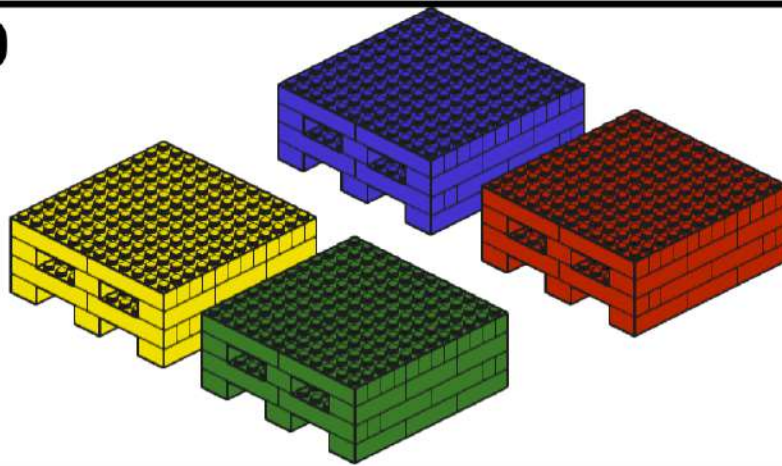

水瓶(三個)

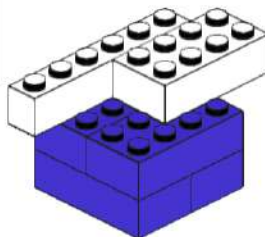
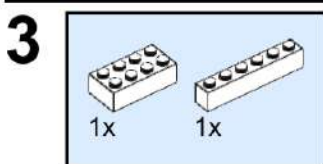
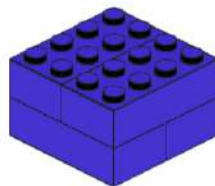
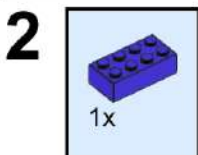
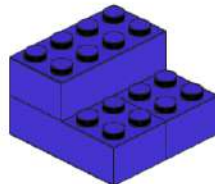
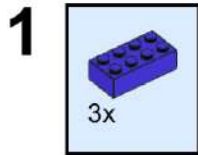

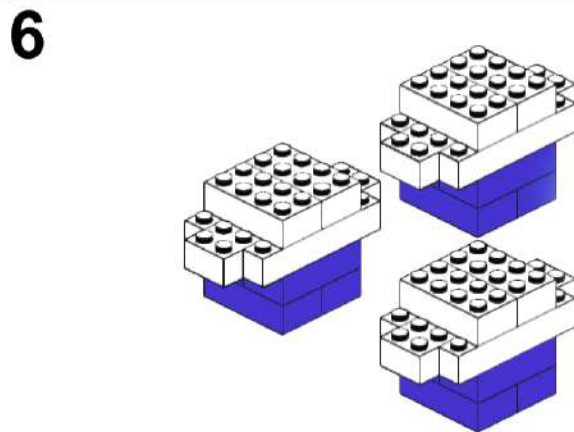
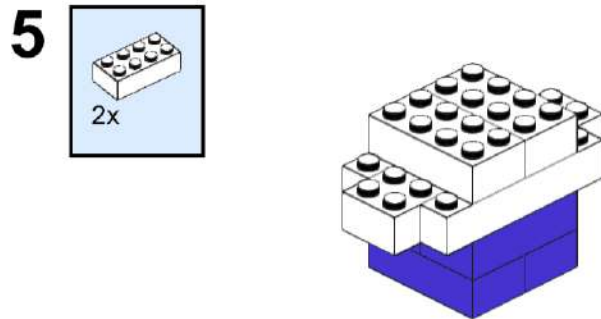
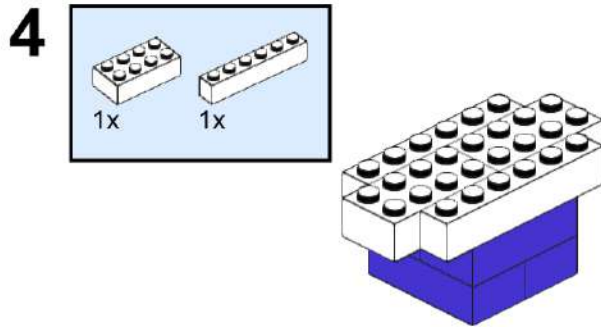

人員(一個黃色、一個綠色、一個紅色、一個藍色、一個白色、一個黑色)

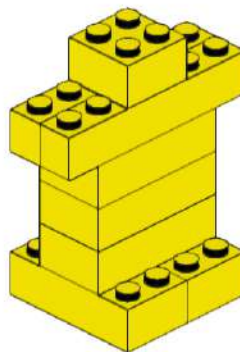
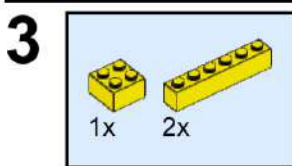
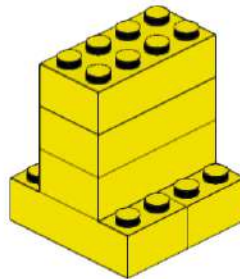
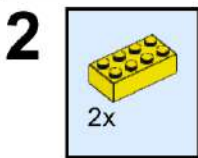
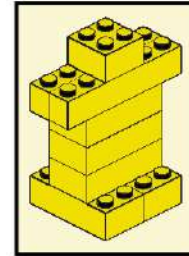
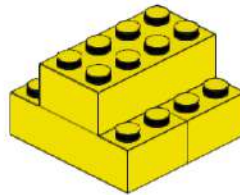
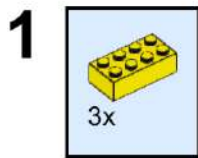

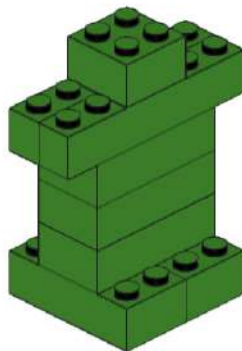
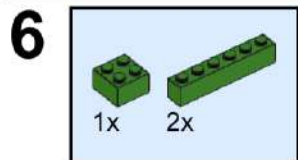
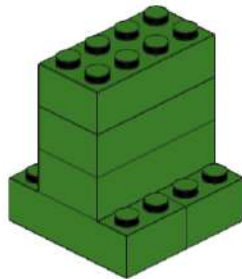
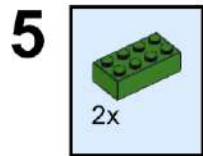
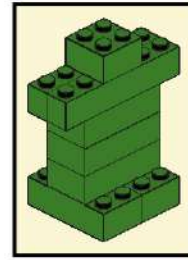
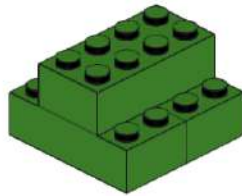
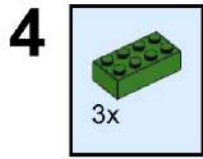

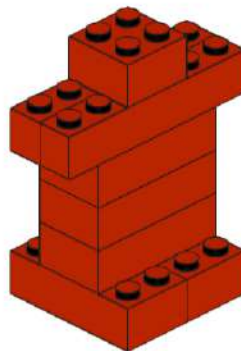
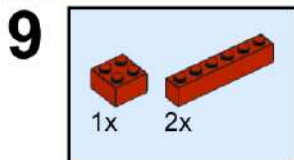
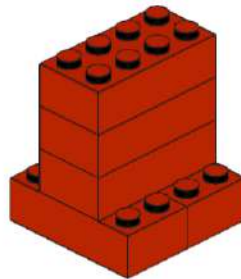
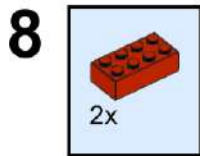
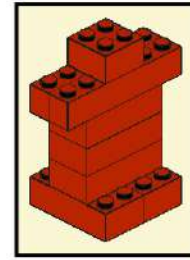
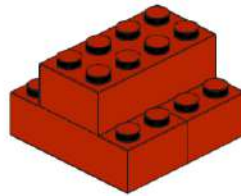
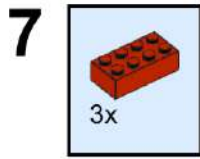

10

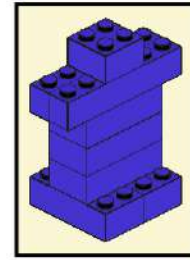
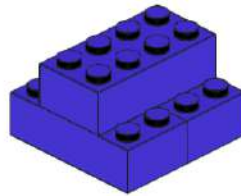
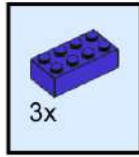

11

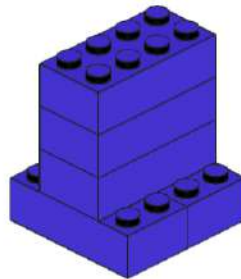
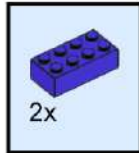

12

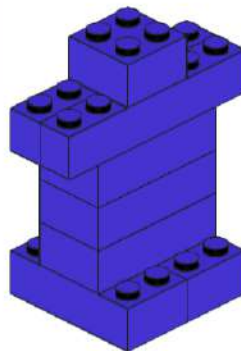
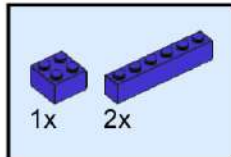

13

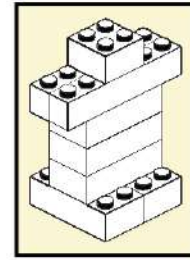
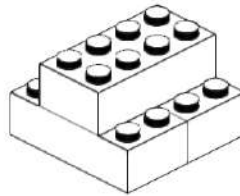
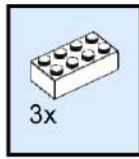

14

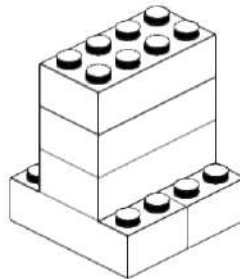
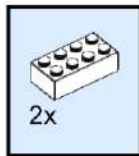

15

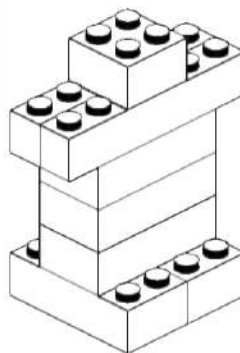
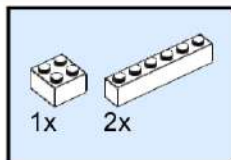

16

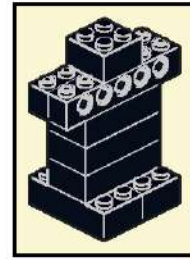
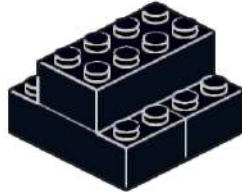

17



18

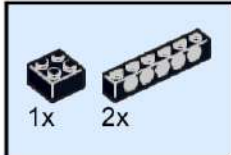

19

