



World Robot Olympiad 2021

Regular Category

Junior



Park and Charge

Official Game Rules for the WRO International Final
(Note: Rules for local WRO events may vary!)

Version: January 15th

WRO International Premium Partners





WRO 2021 - Regular Category - Junior

Table of Contents

PART ONE – GAME DESCRIPTION	3
1. Introduction	3
2. Game Field	4
3. Game Objects, Positioning, Randomization	5
4. Robot Missions	8
4.1. Sorting parked cars	8
4.2. Sorting waiting cars	9
4.3. Charge the cars	9
4.4. Park the robot	9
4.5. Get bonus points	9
5. Scoring	10
6. Local, regional, and international events	18
PART TWO – ASSEMBLY OF GAME OBJECTS	19



WRO 2021 - Regular Category - Junior

PART ONE – GAME DESCRIPTION

1. Introduction

There are more and more electric cars on our roads, and in many places a new infrastructure is being built to be able to charge these cars in time.

Since charging an electric car currently takes several hours and cannot be done in a few minutes at the gas station, new ways have to be found.

One idea is to charge the cars while they are standing in a parking lot. In an intelligent parking garage of the future, a robot organizes the parking of the cars and brings electric or hybrid vehicles a battery to charge.

You can get inspired by mobile charging batteries or parking garage robots by watching one of the following videos:

<https://www.youtube.com/watch?v=4TdzfsssYWw>

https://www.youtube.com/watch?v=yMC1H_xL3Y

<https://www.youtube.com/watch?v=VIP-9e9PxFc>

This is the task of the robot on the junior playing field. The robot needs to pick up vehicles at the entrance of the parking garage and bring them to the correct parking space, depending on the type of vehicle. After that, the robot needs to distribute batteries for charging hybrid and electric vehicles.

2. Game Field

The following graphic shows the game field with the different areas.

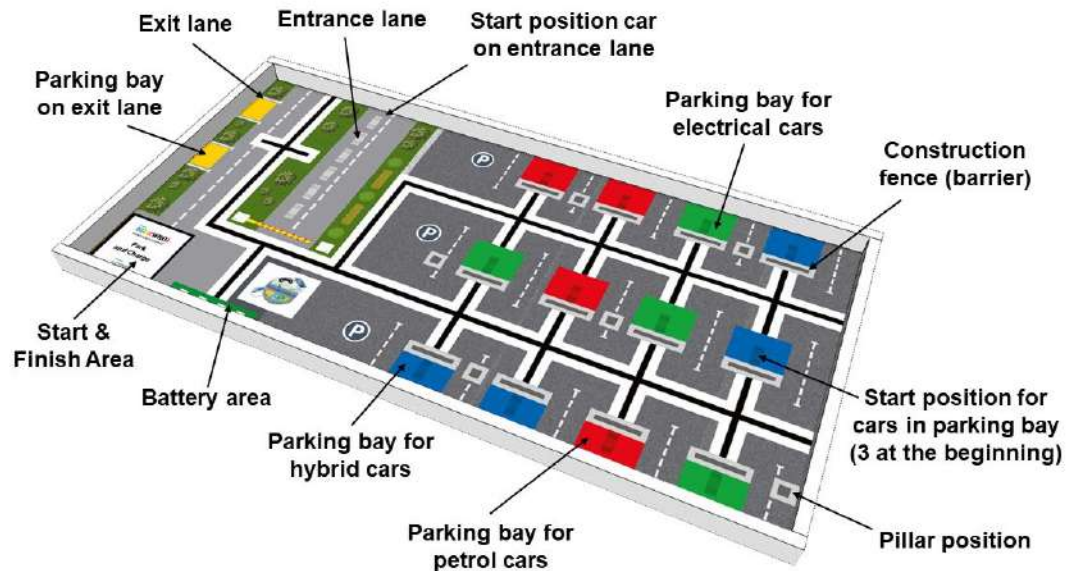

If the table is larger than the game mat, place the mat on the wall with the two sides of the start area.

For more information about the table and game mat specifications, please take a look at WRO Regular Category General Rules, Rule 4. The printable file of the mat is available on www.wro-association.org.

3. Game Objects, Positioning, Randomization

Waiting cars (2x green, 2x blue, 2x red)

There are six waiting cars in the entrance lane of the parking garage. There are always two green (electrical), two blue (hybrid), and two red (petrol) cars. The cars are **randomly placed in each round** on the little rectangles in the entrance lane.

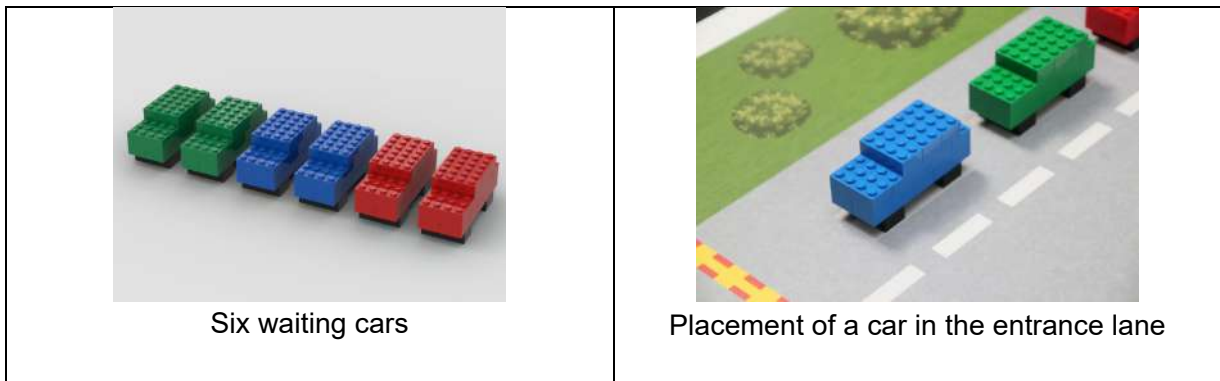

Parked cars (1x green, 1x blue, 1x red)

There are three cars parked in the parking garage. For **the competition day**, the cars are **randomly placed on the parking bays**. The red car is always placed on a green or blue parking bay. The blue and green cars are always placed on a parking bay of their color.

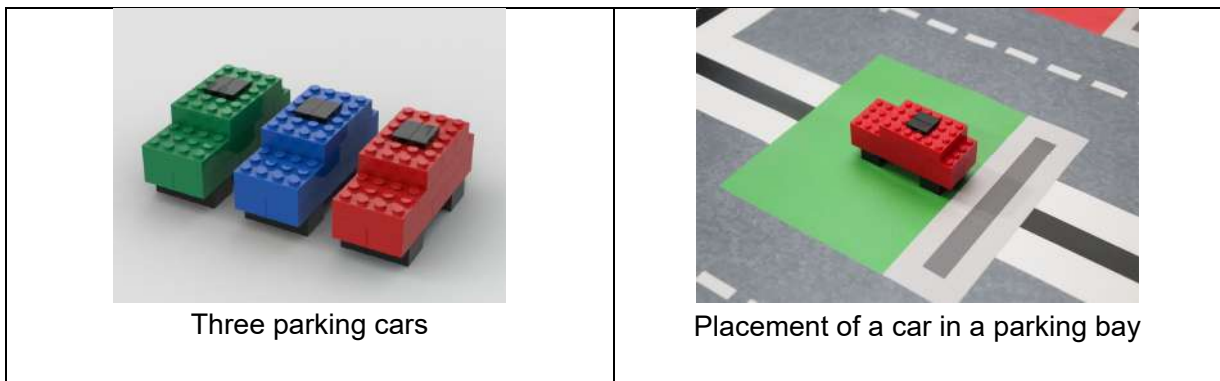

Note: The referee can see the difference of a waiting and parking car because the parking cars have the little black LEGO tiles on top.

Pillars (3x)

There are three pillars that are used to support the constructions of the parking garage. The pillars are **randomly placed in each round** on the six grey squares in the parking garage (never two pillars in one parking row).

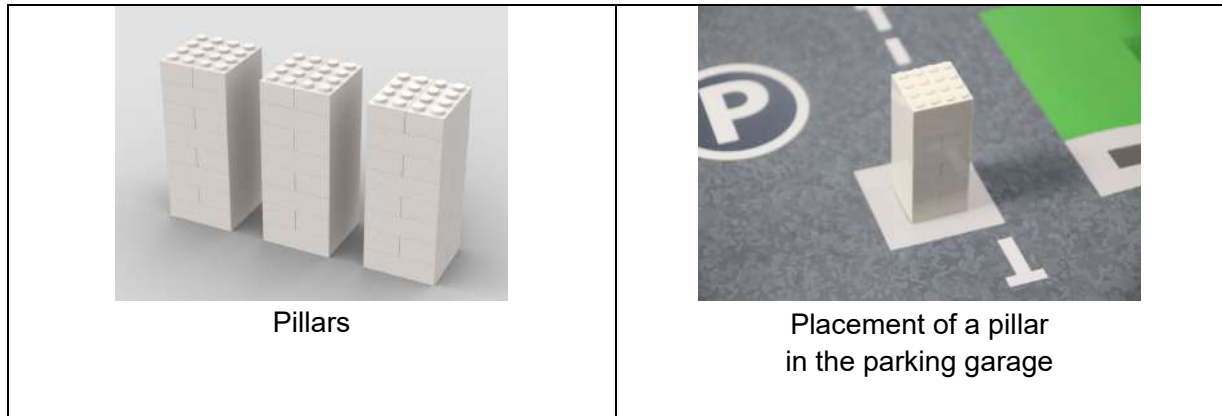

Barriers (2x)

There are two barriers that are used to mark a parking bay that is currently under construction. The barriers are **randomly placed in each round** in front of two empty parking bays (not in front of a parking bay with a parked car, never two barriers in one parking row and never two barriers on two parking bays of the same color).

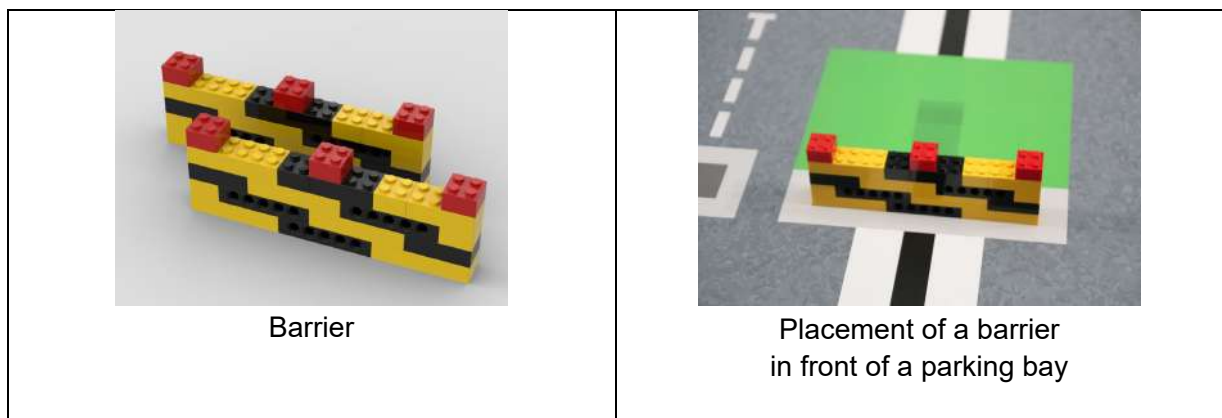

Battery blocks (4x)

There are battery blocks that are always placed on the four positions in the battery area.

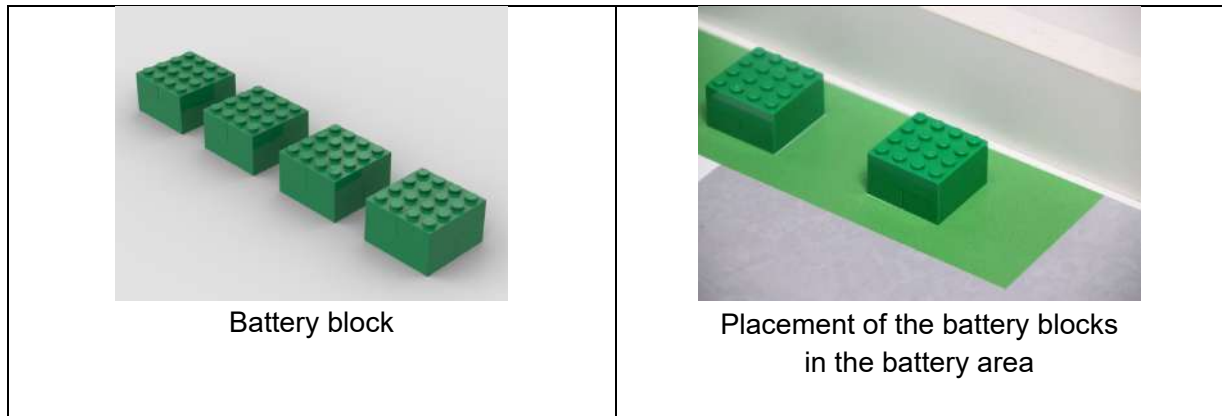

Summary randomization

On the **competition day**, the position of the parked cars is randomly selected.

For **each round**, the following objects are randomly placed:

- Position of the waiting cars in the entrance lane.
- Position of pillars on the grey squares (never two pillars in a parking row, a row is defined by the “P” symbol and the four parking bays on the right)
- Position of barriers in front of empty parking bays (never two barriers in a parking row and never two barriers in front of parking bays of the same color).

One possible randomization you can see here (green X for green car, blue X for blue car, red X for red car, white X for pillar, yellow X for the barriers):

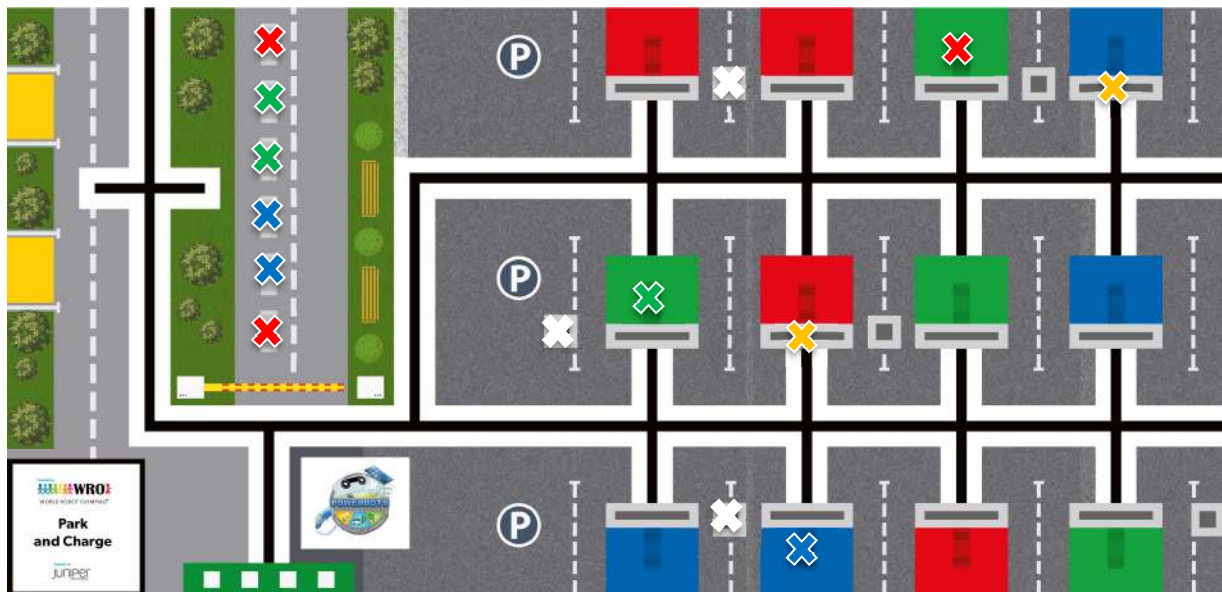

4. Robot Missions

For a better understanding, the missions will be explained in multiple sections.

The team can decide in which order they will do the missions.

4.1. Sorting parked cars

From time to time, the robot checks the cars at the different parking bays. All cars should be on the correct parking bay and fully charged cars should be brought to the exit lane.

The robot should do the following:

- Bring the red car to a red parking bay without a barrier in front because there has been a mistake in sorting before. Full points are awarded if the red car is completely inside the red parking bay without a barrier in front.
- Bring the green and blue car to the exit lane, because they are fully charged. Full points are awarded if the cars are completely inside the yellow areas in the exit lane (only one car per parking bay counts). If there are two cars inside / touching a parking bay, you will get zero points.

4.2. Sorting waiting cars

It is the task of the parking garage robot to bring the cars from the entrance lane to the corresponding parking bays. A green car should go to a green parking bay, a blue car to a blue parking bay and a red car to a red parking bay.

The robot should be careful and not bring a car to a parking bay that is currently under construction (marked with a barrier in front of the parking bay).

Some points are awarded if a car is completely inside any parking bay without a barrier in front. Full points are awarded if the car is completely inside the corresponding parking bay (green car in green parking bay, etc.) and without a barrier in front. Here, the full green / blue / red area plus the grey area of the barrier count as the area of the parking bay.

4.3. Charge the cars

Once the cars are parked completely inside the correct parking bay, the robot can bring the batteries to the electrical and hybrid cars.

Some points are awarded if the battery is touching **a green parking bay with a green car or a blue parking bay with a blue car**, full points are awarded if the battery is completely inside the parking bay. Only one block per parking bay counts. If there are two or more blocks inside / touching a parking bay, you will get zero points.

4.4. Park the robot

The mission is complete when the robot returns to the Start & Finish area, stops, and the chassis of the robot is entirely (top-view) within the Start & Finish area (cables are allowed to be outside of the Start & Finish area).

4.5. Get bonus points

Bonus points will be awarded for not moving or damaging the barriers and for not moving or damaging the pillars.

5. Scoring

Definitions for the scoring

“Completely” means that the game object is only touching the corresponding area (not including the black lines). In a case of a parking bay, the grey markings for the barriers count towards the parking bay area. Cars always need to stand with studs on top to count points and are completely in area if the base of the object (here: the wheels) are completely in area.

Important (more than 2 cars): If more than one car is completely in the same parking bay, there are no points for these cars. In this case, there are no points for a battery block in that parking bay as well.

Tasks	Each	Total
Sorting parked cars (cars with black tiles on top)		
Petrol car completely in a red petrol parking bay without a barrier in front.		10
Electrical and hybrid car touching the parking bay in the exit lane (only one car per parking bay counts).	6	12
Electrical and hybrid car completely inside the parking bay in the exit lane (only one car per parking bay counts).	8	16
Sorting waiting cars (cars without black tiles on top)		
Car completely in a parking bay of a different color without a barrier in front.	4	24
Car completely in a parking bay of the corresponding color and without a barrier in front.	8	48
Charge the cars (only one block per parking bay counts)		
Battery block touching a green or blue parking bay with a correct car.	4	16
OR: Battery block completely inside a green or blue parking bay with a correct car.	6	24
Park the robot		
Robot completely stops in the Start & Finish Area <i>(only if other points, not bonus, are assigned)</i>		7
Get bonus points		
Pillar is not moved or damaged.	5	15
Barrier is not moved or damaged.	5	10
Maximum Score		130



Scoring Sheet

Team name: _____

Round: _____

Tasks	Each	Total	#	Total
Sorting parked cars (cars with black tiles on top)				
Petrol car completely in a red petrol parking bay without a barrier in front.		10		
Electrical and hybrid car touching the parking bay in the exit lane (only one car per parking bay counts).	6	12		
Electrical and hybrid car completely inside the parking bay in the exit lane (only one car per parking bay counts).	8	16		
Sorting waiting cars (cars without black tiles on top)				
Car completely in a parking bay of a different color without a barrier in front.	4	24		
Car completely in a parking bay of the corresponding color and without a barrier in front.	8	48		
Charge the cars (only one block per parking bay counts)				
Battery block touching a green or blue parking bay with a correct car.	4	16		
OR: Battery block completely inside a green or blue parking bay with a correct car.	6	24		
Park the robot				
Robot completely stops in the Start & Finish Area <i>(only if other points, not bonus, are assigned)</i>		7		
Get bonus points				
Pillar is not moved or damaged.	5	15		
Barrier is not moved or damaged.	5	10		
Sum of Game Score		130		
				Surprise Rule
				Total Score in this run
				Time in full seconds

Signature Team

Signature Judge

Scoring Interpretation

Petrol car completely in a red petrol parking bay without a barrier in front. → 10 points

Please note that for these points only parked cars count (cars with black tiles on top).



10 points



10 points (grey part belongs to the parking bay)



0 points (car is outside of the parking bay)



0 points (car needs to stand)

Electrical and hybrid car touching the parking bay in the exit lane. → 6 points each

Please note that for these points only parked cars count (cars with black tiles on top). If two cars are touching the same parking bay, 0 points will be awarded.



0 points
(car not in parking bay)



6 points
(car touching)



0 points
(two cars touching one parking bay)

Electrical and hybrid car completely into the parking bay in the exit lane (only one car per parking bay counts). → 8 points each

Please note that for these points only parked cars count (cars with black tiles on top). If two cars are in / touching the same parking bay, 0 points will be awarded.



8 points (completely inside)

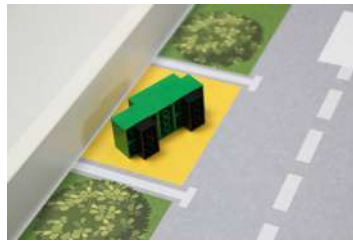

0 points (car not standing)



8 points (all parts touching the exit lane)



0 points (two cars touching the same parking bay)



0 points (two cars touching the same parking bay)

Car completely in a parking bay of a different color without a barrier in front. → 4 points each

Please note that for these points only waiting cars count (cars without black tiles on top).



4 points



4 points (grey part belongs to the parking bay)

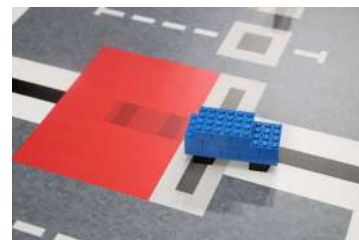

0 points (outside)

Car completely in a parking bay of the corresponding color and without a barrier in front.
→ 8 points each

Please note that for these points only waiting cars count (cars without black tiles on top).

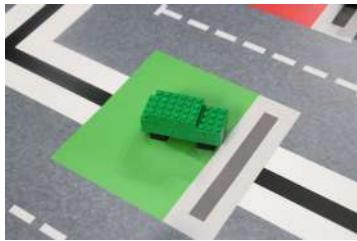

8 points

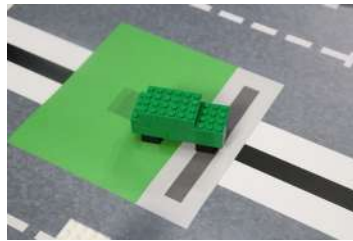

8 points (grey part belongs to the parking bay)

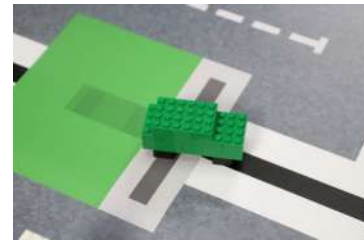

0 points (outside)



0 points (car need to stand)

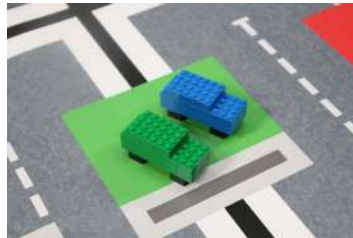

0 points (two cars in bay)

Battery block touching a green or blue parking bay with a correct car. → 4 points each

Please note that if two blocks are touching the same parking bay, 0 points will be awarded.

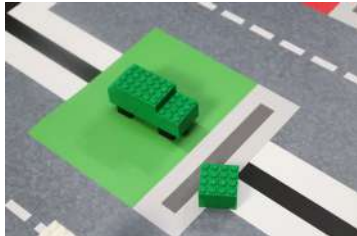

4 points (partly touching)

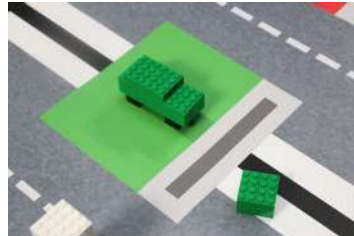

0 points (outside)



0 points (not a correct car)



0 points (two blocks touching the same parking way)

OR: Battery block completely inside a green or blue parking bay with a correct car. → 6 points each

Please note that if two blocks are completely in the same parking bay, 0 points will be awarded.

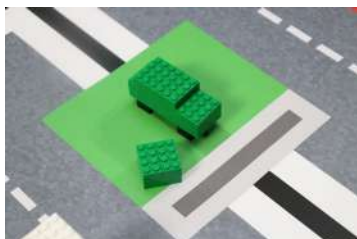

6 points

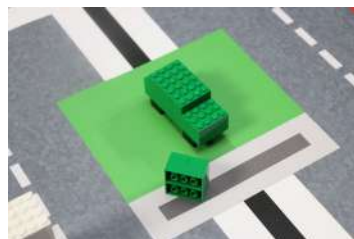

6 points

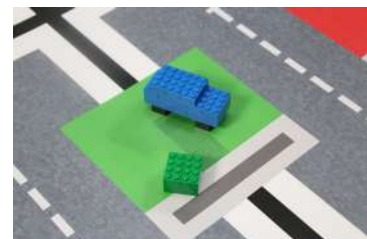

0 points (not a correct car)

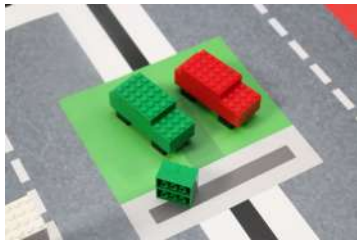

0 points (two cars in bay)

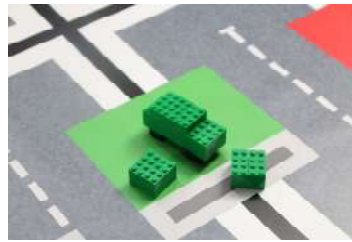

0 points (two blocks inside the same parking bay)

Robot completely stops in the Start & Finish Area (only if other points, not bonus, are assigned) → 7 points



The projection of the robot is completely inside the start/finish area.



The projection of the robot is completely inside, and cables are out. That is still OK.

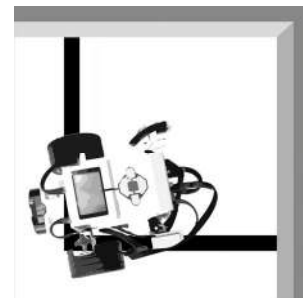

No points if the projection of the robot is not in the start/finish area.

Pillar is not moved or damaged. → 5 points each



5 points, not moved.



5 points, only moved inside the grey area.



0 points, moved outside of grey area.



0 points, damaged.

Barrier is not moved or damaged. → 5 points each



5 points



5 points, only moved inside the grey area.



0 points, moved outside of grey area.



0 points, damaged.



WRO 2021 - Regular Category - Junior

6. Local, regional, and international events

WRO competitions take place in around 90 countries, and we know that teams in each country expect a different level of complexity. The challenge as described in this document will be used for international WRO events. This is the last stage of the competition, where the teams with the best solutions participate. That is why the game rules are challenging.

WRO feels that all participants need to be able to have a good experience in the competition. Teams with less experience should also be able to score points and succeed. This builds confidence in their ability to master technical skills, which is important for their future choices in education.

This is why WRO Association recommends that our National Organizers decide if they want to adapt the rules for events in their country. They can make the challenges easier for local, regional, and national events, so that all participants have a positive experience. Our National Organizers can make their own choices, so each competition fits their specific situation and ideas. Here, we provide some ideas to make the challenges easier.

Ideas for simplifications:

- Fixed positions of the parked cars
- Randomization of the barriers only on the competition day
- No randomization of the cars in the entry lane

PART TWO – ASSEMBLY OF GAME OBJECTS

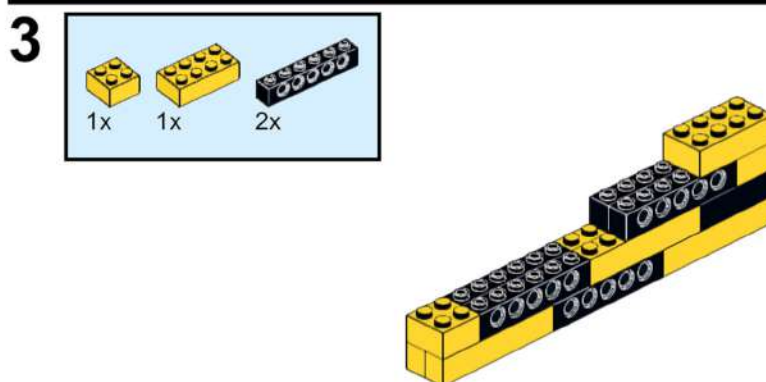
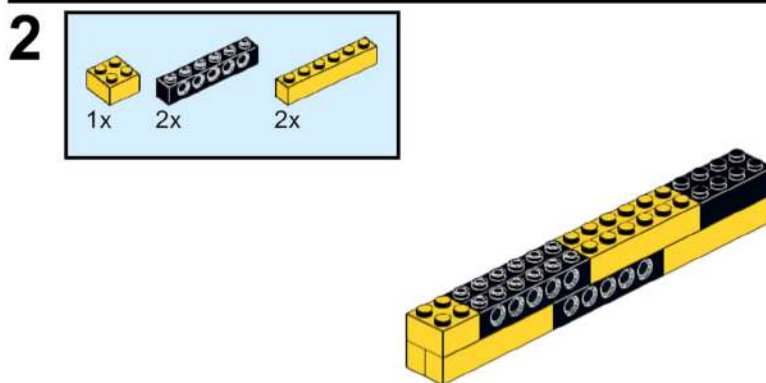
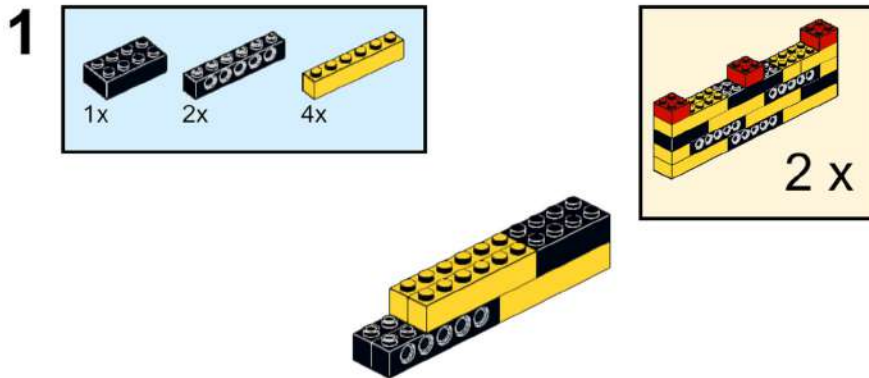

4

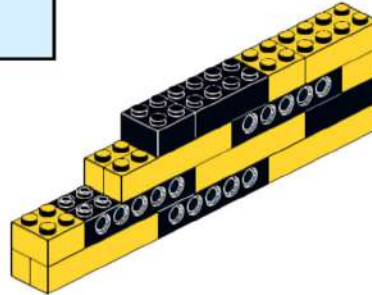
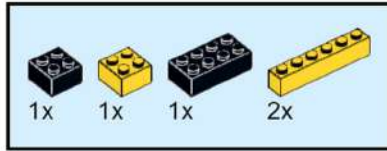

5

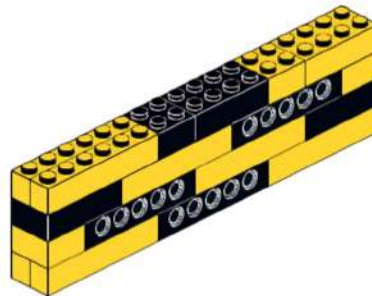
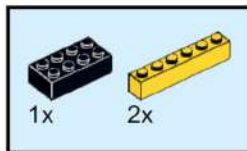

6

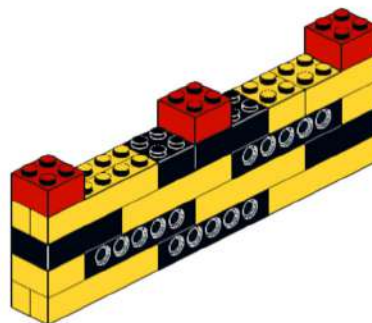

7

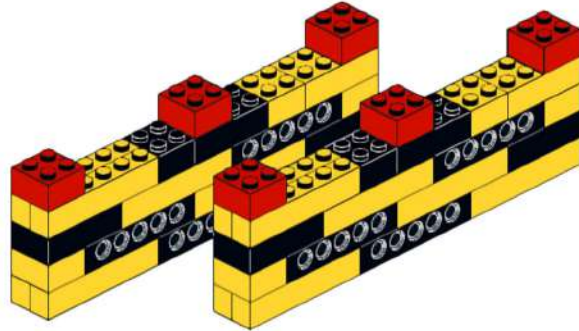

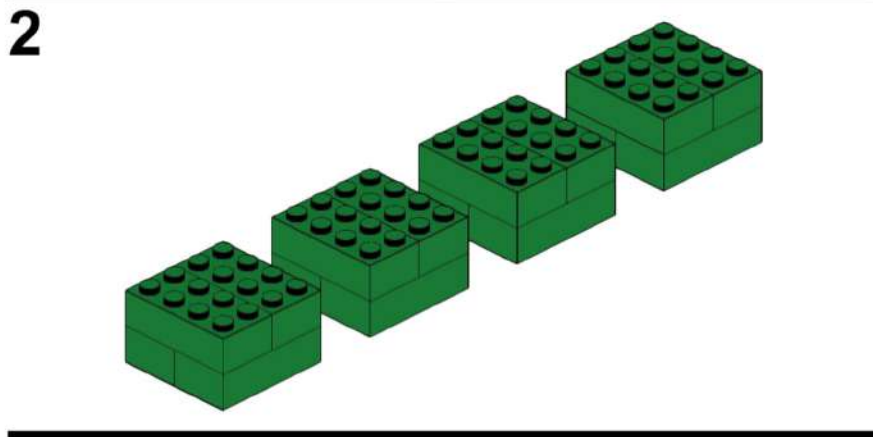
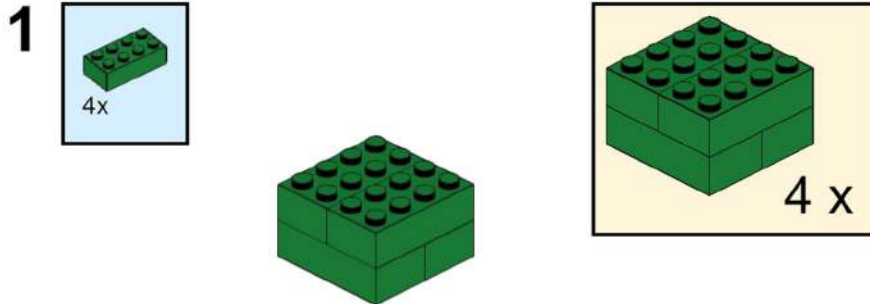

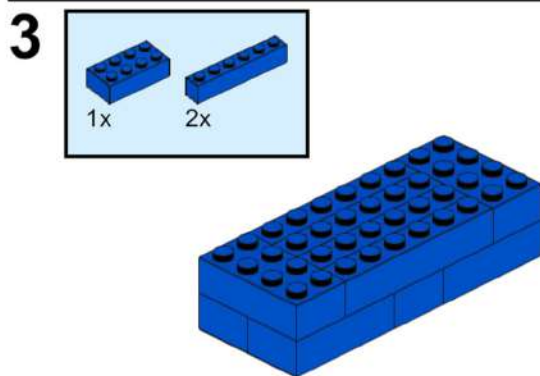
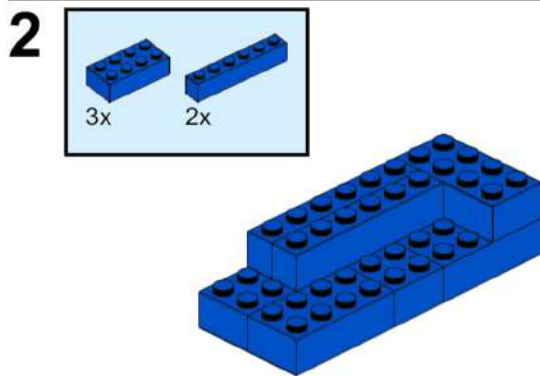
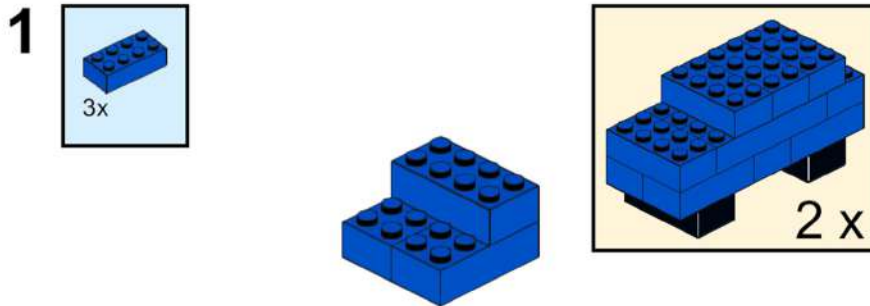

4 
3x

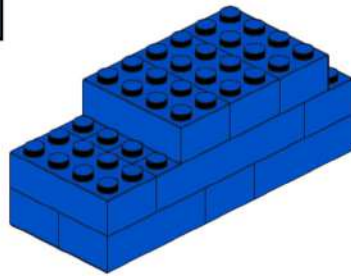

5 
2x

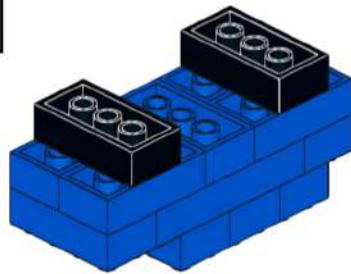

6

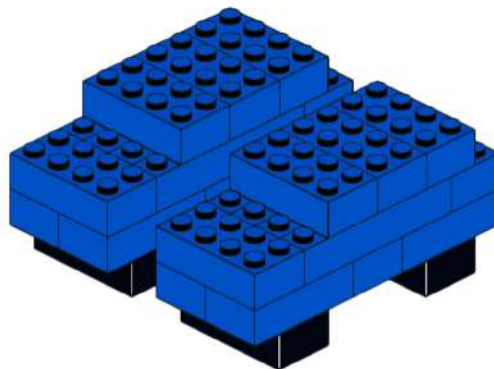

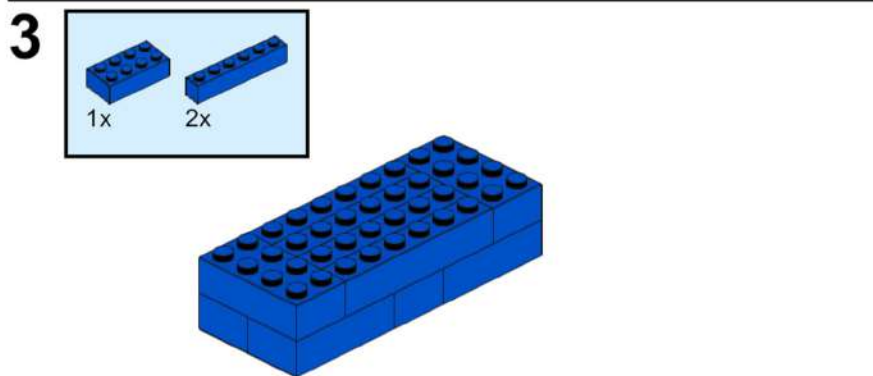
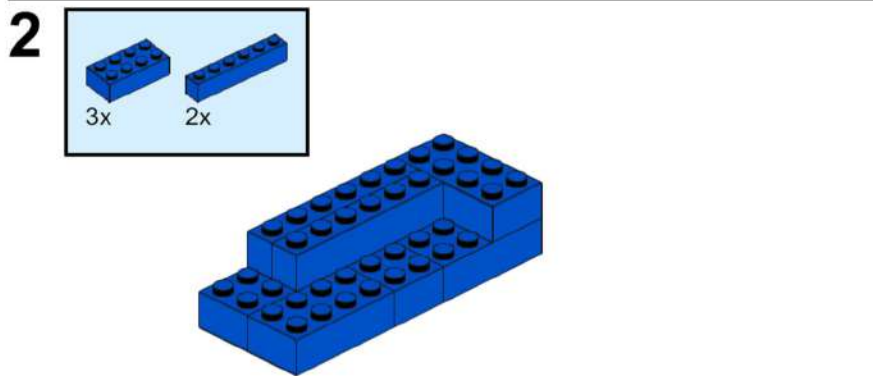
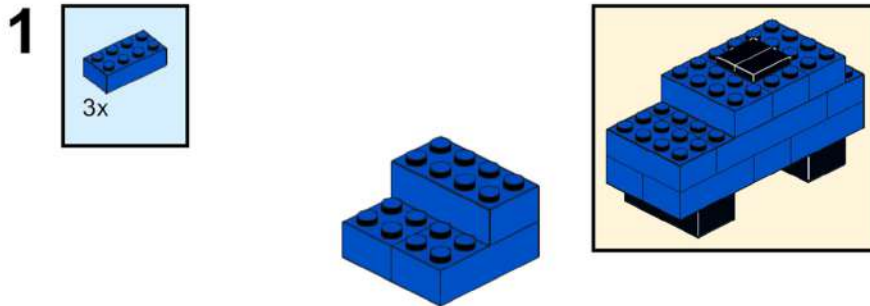

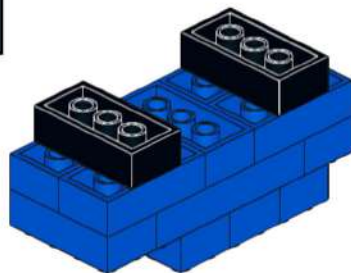
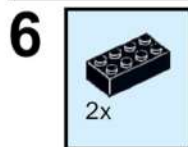
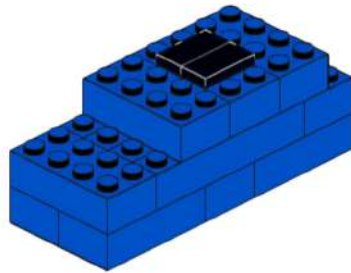
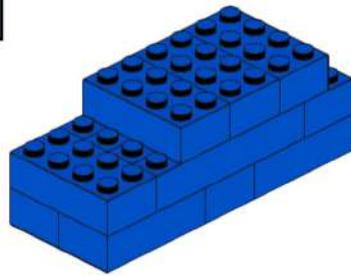
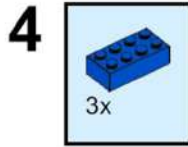

7

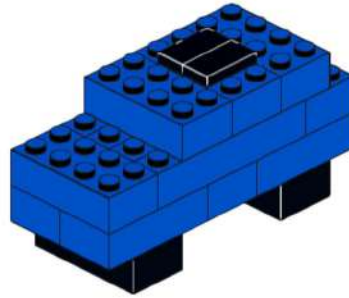

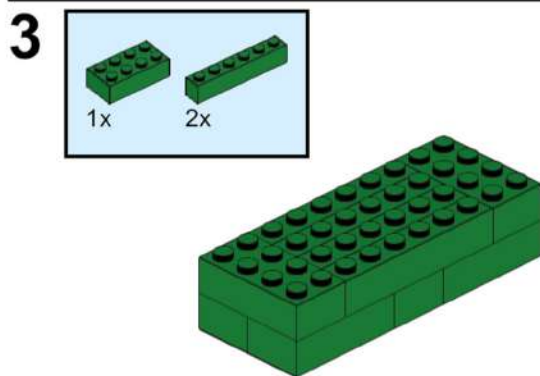
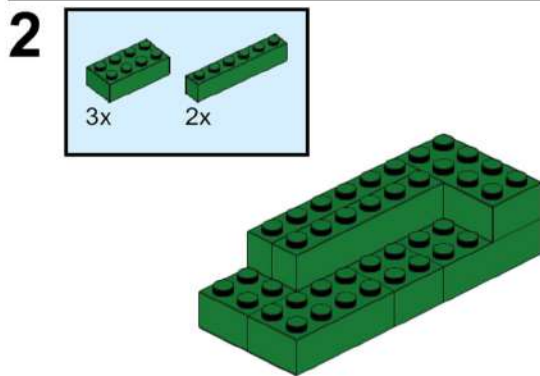
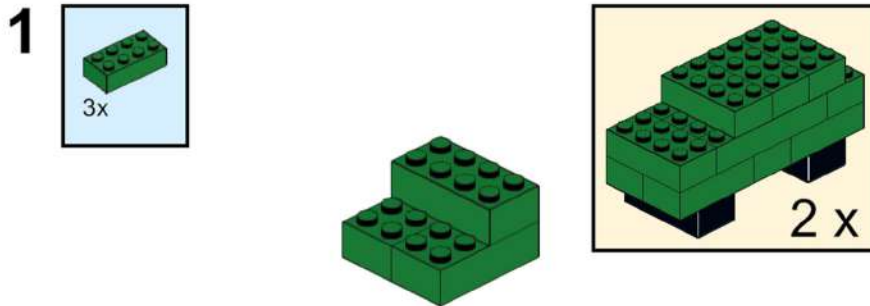

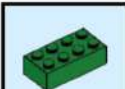

4

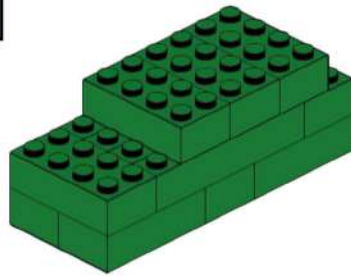

3x



5



2x

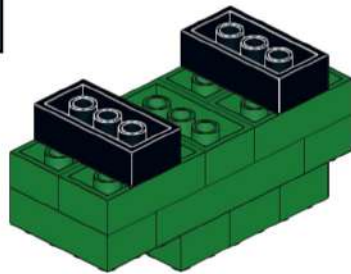

6

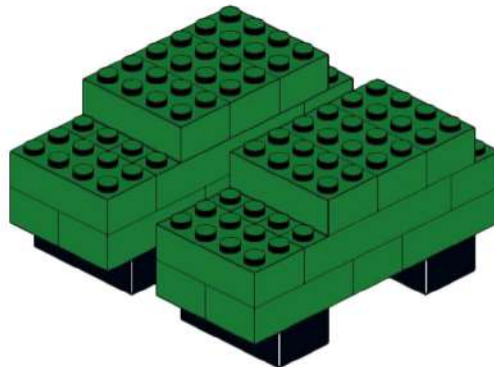

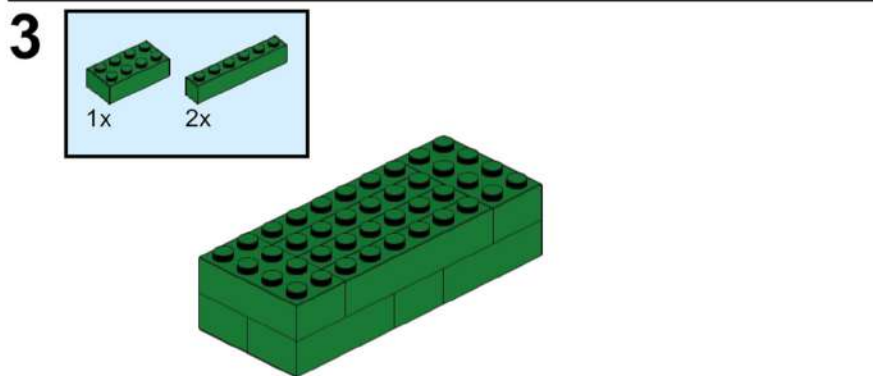
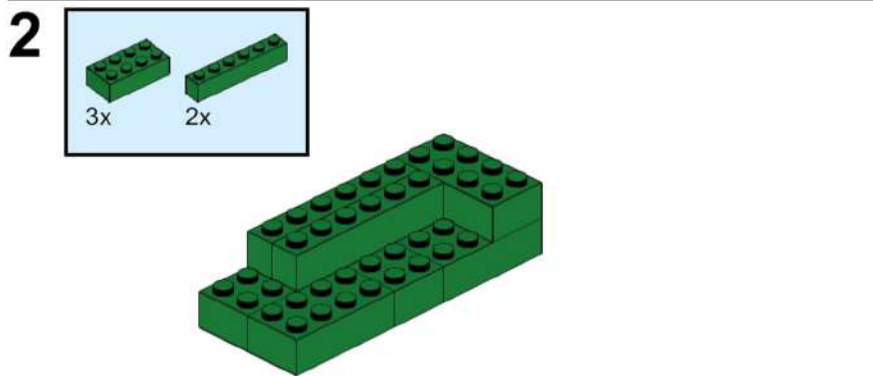
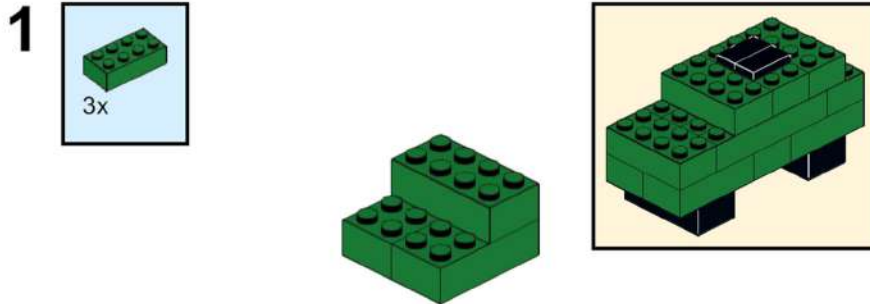

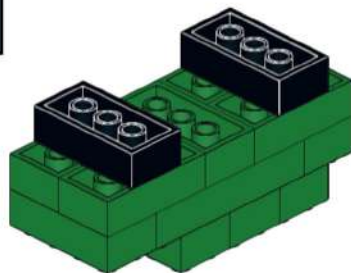
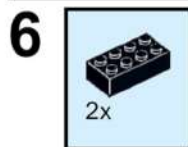
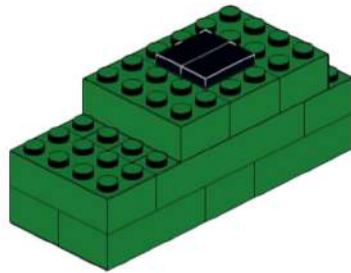
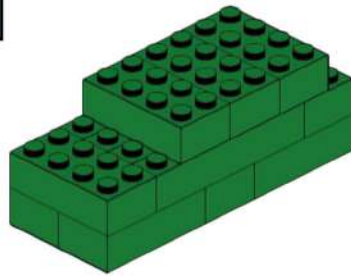
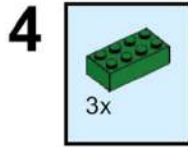

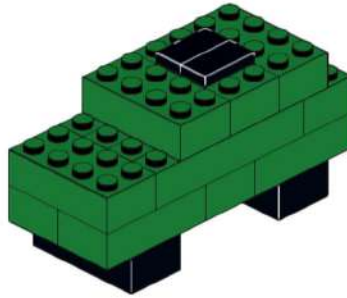

7

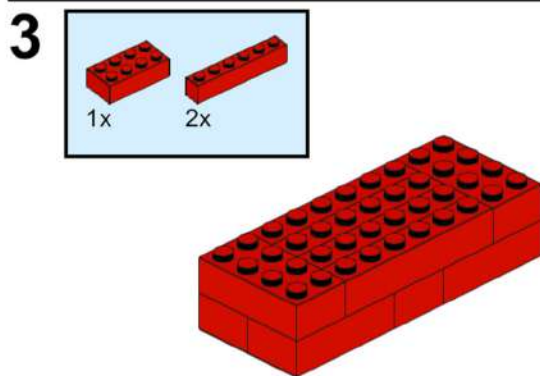
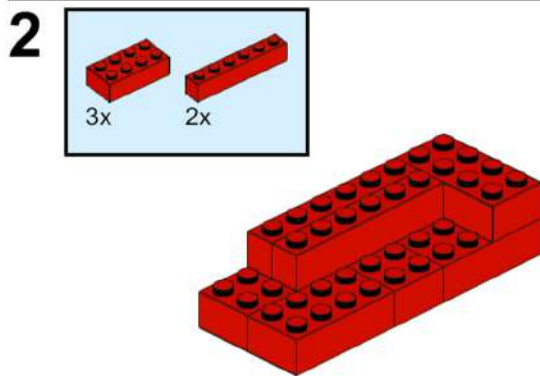
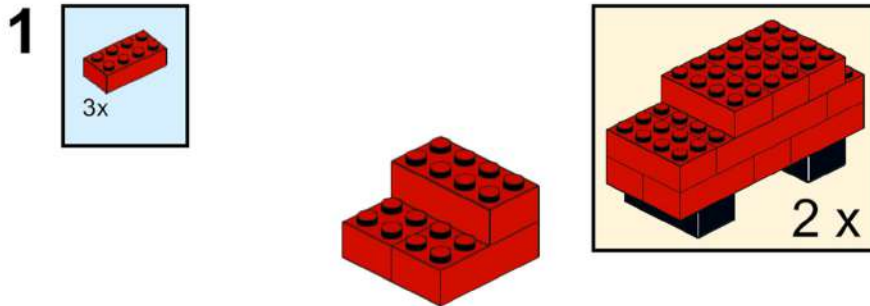

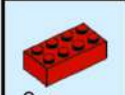

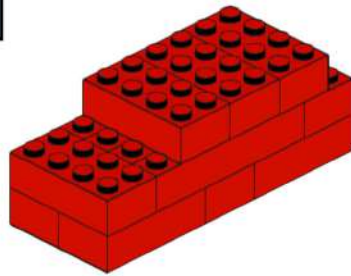
4 
3x



5 
2x

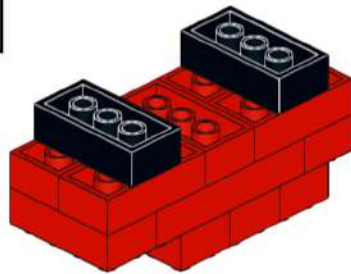

6

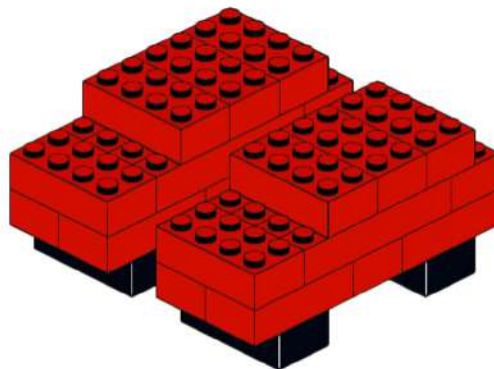

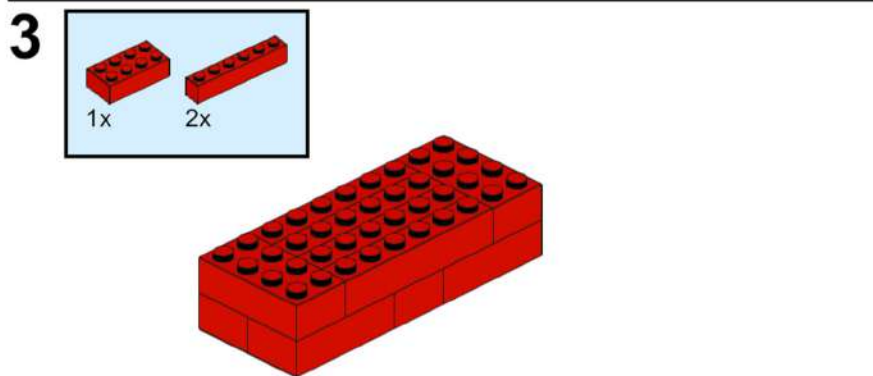
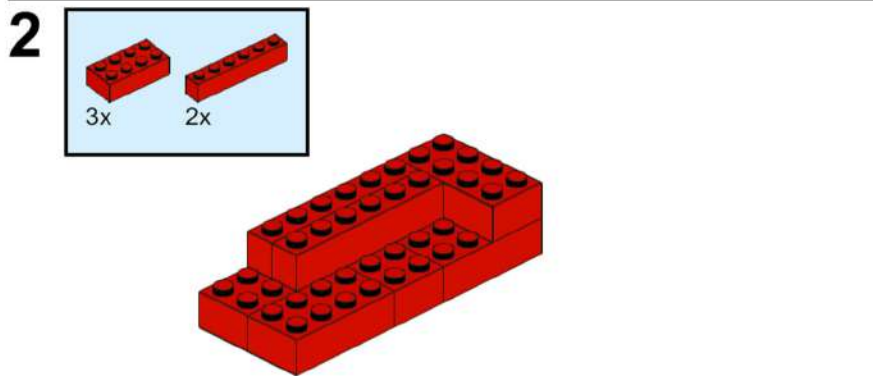
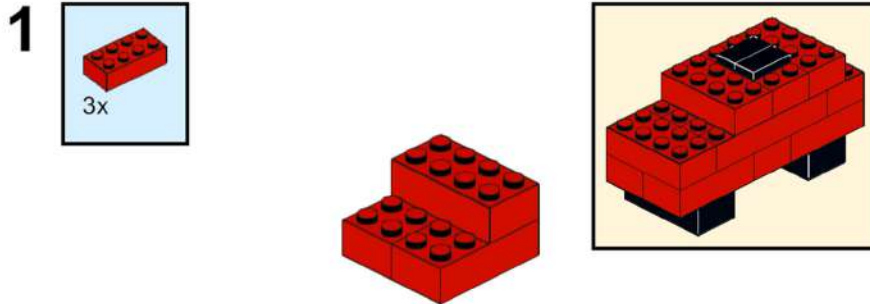

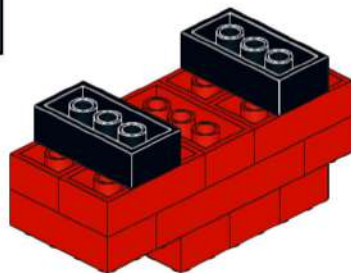
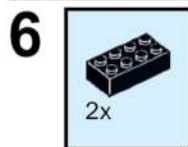
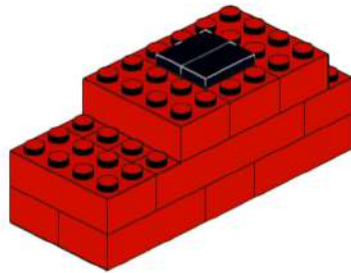
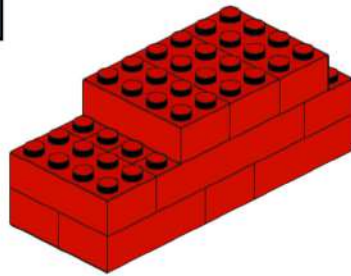
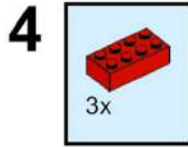

7

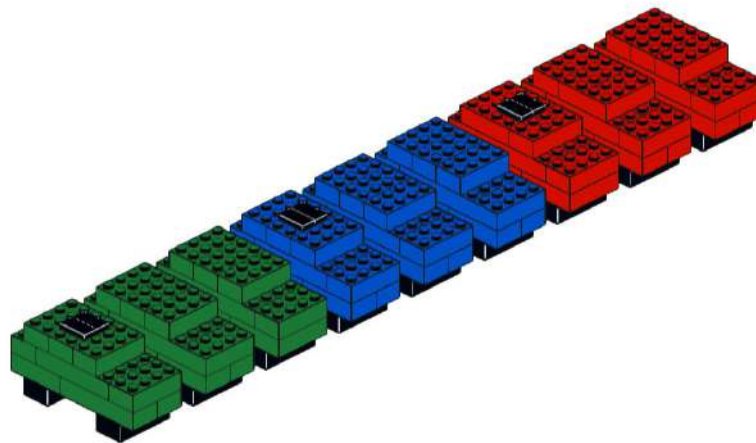
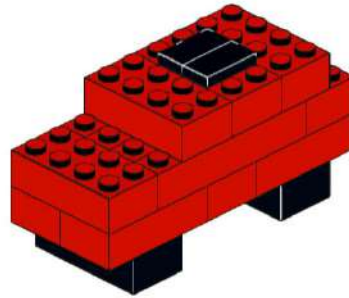

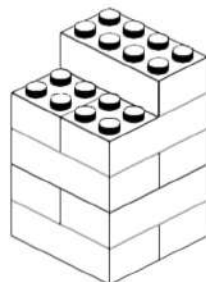
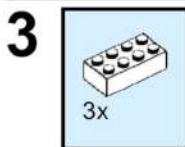
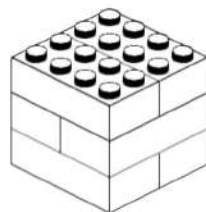
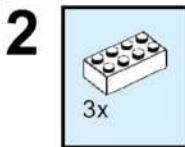
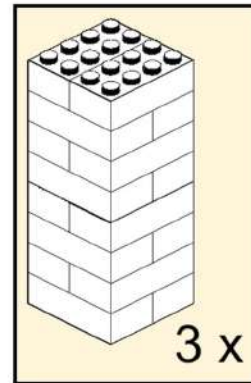
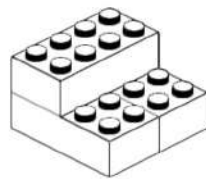
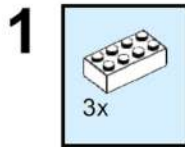

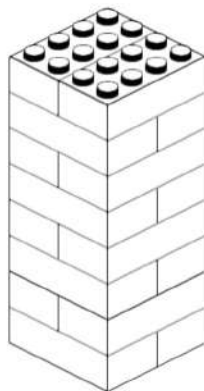
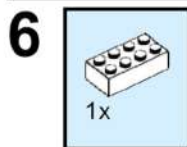
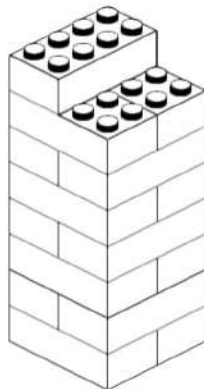
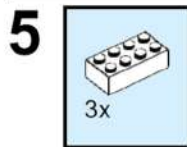
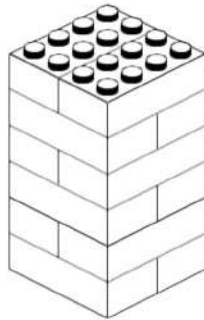
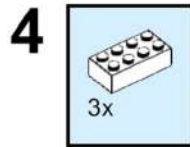

7

